

ENGLISH



Canon DIGITAL CAMERA *PowerShot SX100 IS* Camera User Guide

Canon

PowerShot SX100 IS

Camera User Guide

Canon



Getting Started

Learning More

Components Guide

Basic Operations

Commonly Used Shooting Functions

Shooting Using the Mode Dial

Various Shooting Methods

Playback/Erasing

Print Settings/Transfer Settings

Connecting to a TV

Troubleshooting

List of Messages

Appendix

Ensure that you read the Safety Precautions (pp. 176 – 185).

Workflow and Reference Guides

The following guides are available. Refer to them as necessary according to the flowchart below.

 : Contents of This Guide

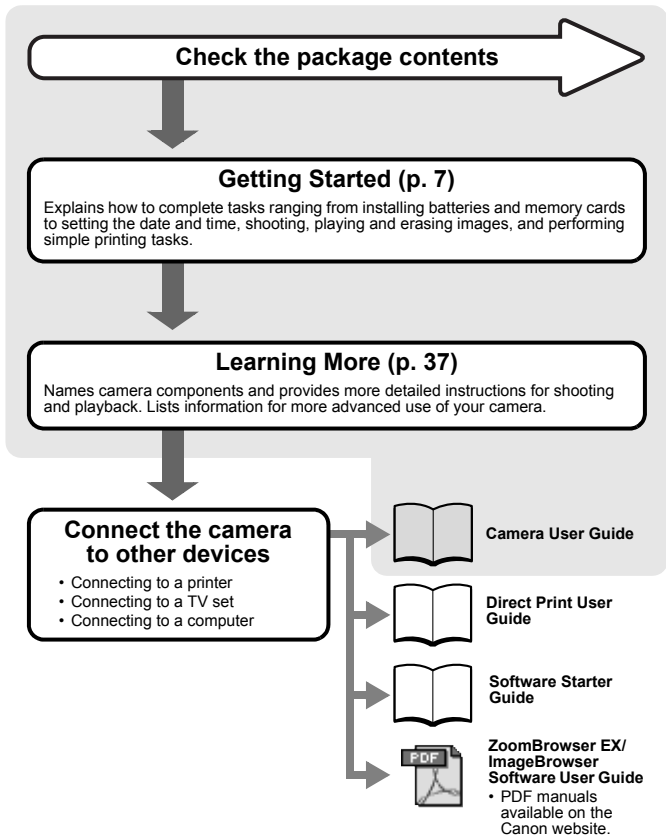

<http://web.canon.jp/Imaging/information-e.html>

Checking the Package Contents

The following items are included in the package. If something is missing, please contact the retail outlet at which you purchased the product.

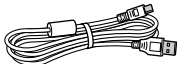
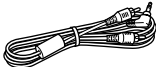
1 Camera**2 AA Alkaline Batteries (×2)****3 Memory Card (16MB)****4 Interface Cable IFC-400PCU****5 AV Cable AVC-DC300****6 Wrist Strap WS-200****7 Canon Digital Camera Solution Disk****8 Warranty Card****9 User Guides**

- Camera User Guide
- Direct Print User Guide
- Software Starter Guide
- "Canon Customer Support" Leaflet

You may not be able to achieve the full performance of this camera with the included memory card.





You can use SD memory cards, SDHC (SD High Capacity) memory cards, MultiMediaCards, MMCplus cards and HC MMCplus cards in this camera. These memory cards are collectively referred to as memory cards in this guide.

Table of Contents

Items marked with a ☆ are lists or charts that summarize camera functions or procedures.

Please Read

6

Getting Started	7
Preparations	8
Shooting Still Images ( Mode)	14
Viewing Still Images	17
Shooting Movies ( Standard Mode)	18
Viewing Movies	20
Erasing	21
Printing	22
Downloading Images to a Computer	24
System Map	32

Learning More

37

Components Guide

38

Using the Control Dial	41
 Button	42
Indicators	43
Power Saving Function	43

Basic Operations









44

☆ Menus and Settings	44
☆ Menus and Default Settings	46
Using the LCD Monitor	51
LCD Monitor Brightness	52
Information Displayed on the LCD Monitor	53
Resetting Settings to Their Default Values	58
Formatting Memory Cards	59

Commonly Used Shooting Functions

60

  Shooting with the Optical Zoom	60
--	----

Using the Digital Zoom/ Digital Tele-Converter	61
 Using the Flash	65
 Shooting Close-ups (Macro)	66
 Using the Self-Timer	67
Changing the Recording Pixels (Still Images)	69
Changing the Compression (Still Images)	70
Configuring the Postcard Mode	71
Embedding the Date in the Image Data	72
Setting the Image Stabilizer Function	73
Shooting Using the Mode Dial	75
<hr/>	
Mode Dial	75
Shooting Modes for Specific Scenes	76
 Movie Shooting	79
 Shooting Panoramic Images (Stitch Assist)	83
P Program AE	85
Tv Setting the Shutter Speed	86
Av Setting the Aperture	88
M Manually Setting the Shutter Speed and Aperture	90
Various Shooting Methods	91
<hr/>	
 Continuous Shooting	91
Setting the Red-Eye Reduction Function	93
Setting the Slow Synchro Function	94
Checking the Focus and Peoples' Expressions (Focus Check)	95
Switching between Focus Settings	97
Selecting an AF Frame Mode	98
Selecting a Subject to Focus On (When [Face Detect] Is Selected)	101
Shooting Hard-to-Focus Subjects (Focus Lock, AF Lock, Manual Focus, Safety MF)	103
Locking the Exposure Setting (AE Lock)	107
Locking the Flash Exposure Setting (FE Lock)	109
 Adjusting the ISO Speed	110
Reducing Camera Shake When Shooting (Auto ISO Shift)	111
 Adjusting the Exposure Compensation	114
Switching between Metering Modes	115

Adjusting the Tone (White Balance)	116
Shooting in a My Colors Mode	119
Switching between Flash Adjustment Settings	121
Adjusting Flash Compensation Settings	122
Setting the Flash Output	123
Adjusting Exposure for Built-in Flash Shooting (Safety FE) ..	124
 Registering Settings to the Print/Share Button ..	125
Setting the Display Overlays	127
Setting the Auto Rotate Function	128
Creating an Image Destination (Folder)	129
Resetting the File Number	131
Playback/Erasing	133
<hr/>	
🔍 Magnifying Images	133
🗒 Viewing Images in Sets of Nine (Index Playback) ..	134
Check the Focus and Facial Expressions of Subjects (Focus Check Display)	135
🏠 Jumping to Images	138
Viewing Movies (Movie Replay Control Panel)	139
Rotating Images in the Display	141
Playback with Transition Effects	142
Automated Playback (Auto Play)	143
Red-Eye Correction Function	144
Resizing Images	149
Attaching Sound Memos to Images	150
Protecting Images	152
Erasing All Images	153
Print Settings/Transfer Settings	154
<hr/>	
Setting the DPOF Print Settings	154
Setting the DPOF Transfer Settings	159
Connecting to a TV	161
<hr/>	
Shooting/Playback Using a TV	161
Troubleshooting	162
<hr/>	
List of Messages	172
<hr/>	

Appendix	176
Safety Precautions	176
Preventing Malfunctions	181
Battery Handling	182
Handling the Memory Card	184
Using the Power Kits (Sold Separately)	186
Using an Externally Mounted Flash (Sold Separately)	189
Replacing the Date Battery	191
Camera Care and Maintenance	193
Specifications	194
Index	203
☆ Functions Available in Each Shooting Mode	222

■ Symbol Conventions in this Guide

Commonly Used Shooting Functions | 71

Configuring the Postcard Mode

Shooting Mode:

Mode: Shooting () / Playback ()

Available shooting modes

These modes are available

These modes are not available

composing them inside the print area (width-to-height ratio of approximately 3:2) shown in the LCD monitor.

1 Select .

1. Press the button.
2. Use the or button to select and choose with the or button.
3. Press the button.

- The area that will not print displays in gray.
- Approximately 2M recording pixels, and compression settings are fixed to (Fine).

The digital zoom or the digital tele-converter cannot be used in this mode.



: This mark denotes issues that may affect the camera's operation.



: This mark denotes additional topics that complement the basic operating procedures.

Explanations in this guide are based on the camera's default settings at time of purchase.

Please Read

Test Shots

Before you try to photograph important subjects, we highly recommend that you shoot several trial images to confirm that the camera is operating and being operated correctly.

Please note that Canon Inc., its subsidiaries and affiliates, and its distributors are not liable for any consequential damages arising from any malfunction of a camera or accessory, including memory cards, that results in the failure of an image to be recorded or to be recorded in a way that is machine readable.

Warning Against Copyright Infringement

Please note that Canon digital cameras are intended for personal use and should never be used in a manner that infringes upon or contravenes international or domestic copyright laws and regulations. Please be advised that in certain cases the copying of images from performances, exhibitions, or commercial properties by means of a camera or other device may contravene copyright or other legal rights even if the image was shot for personal use.

Warranty Limitations

This camera's warranty is only effective in the country of sale. If a problem arises while the camera is in use abroad, please convey it back to the country of sale before proceeding with a warranty claim to a Canon Customer Support Help Desk.

For Canon Customer Support contacts, please see the customer support list supplied with your camera.

Camera Body Temperature

If your camera is used for prolonged periods, the camera body may become warm. Please be aware of this and take care when operating the camera for an extended period.

About the LCD Monitor

The LCD monitor is produced with extremely high-precision manufacturing techniques. More than 99.99% of the pixels operate to specification. Less than 0.01% of the pixels may occasionally misfire or appear as red or black dots. This has no effect on the recorded image and does not constitute a malfunction.

Video Format

Please set the camera's video signal format to the one used in your region before using it with a TV monitor.

Language Setting

Please see the *Setting the Display Language* (p. 13) to change the language setting.

Getting Started

- **Preparations**
- **Shooting Still Images**
- **Viewing Still Images**
- **Shooting Movies**
- **Viewing Movies**
- **Erasing**
- **Printing**
- **Downloading Images to a Computer**
- **System Map**

Preparations

Installing the batteries

1. Slide the battery cover lock (①) and hold it open while sliding the cover (②) and opening it (③).

Battery Cover Lock

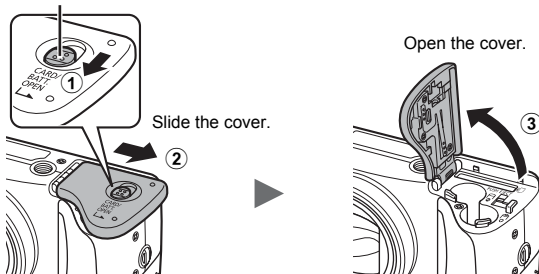

2. Install two batteries.

Negative end (-) Positive end (+)

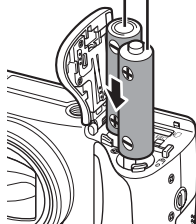

Insert the two supplied
AA-size alkaline batteries.

- 3. Close the cover (④), and press downward as you slide it until it clicks into place (⑤).**

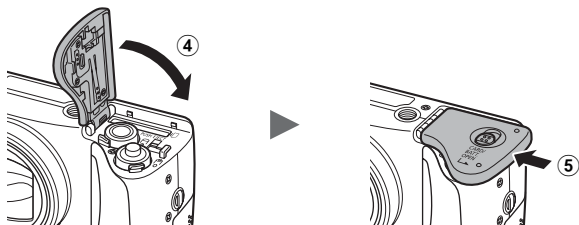

■ Attaching the Wrist Strap

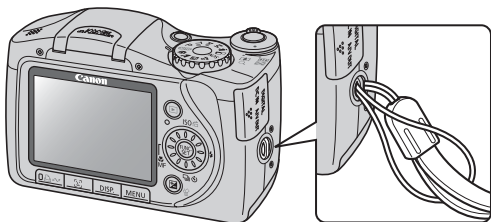

It is recommended to use the wrist strap to avoid dropping the camera during use.

Inserting the Memory Card

1. Slide the battery cover lock (①) and hold it open while sliding the cover (②) and opening it (③).

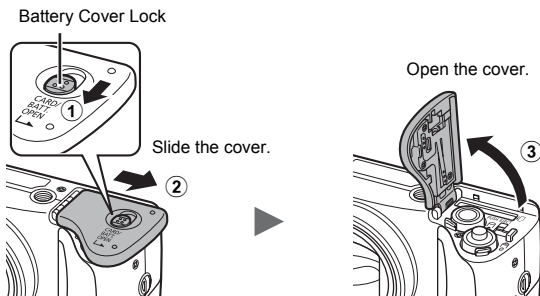

2. Insert the memory card until it clicks into place.

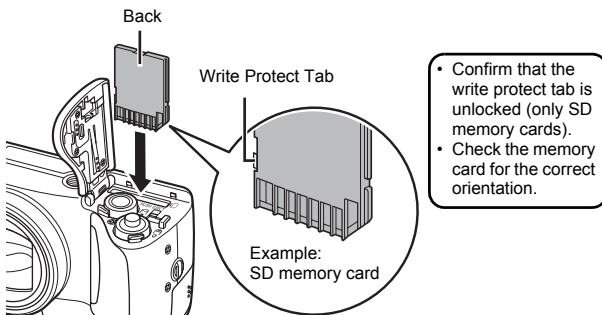

- 3. Close the cover (④), and press downward as you slide it until it clicks into place (⑤).**

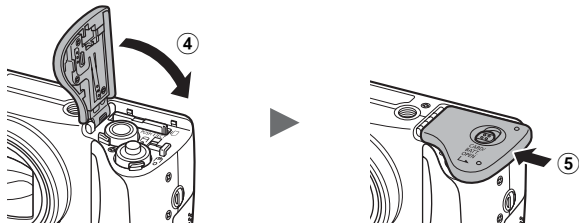

■ To Remove the Memory Card

Push the memory card with your finger until the memory card clicks and then release it.







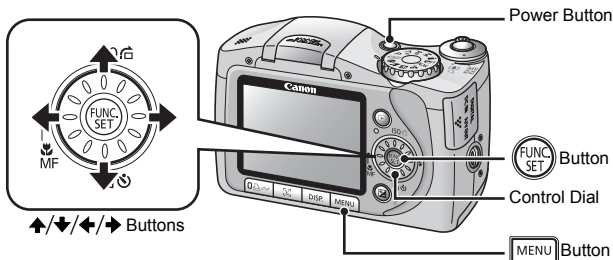

Setting the Date and Time

The Date/Time settings menu will appear the first time the power is turned on. Set the date and time as shown in Steps 3 and 4 in the explanation below.





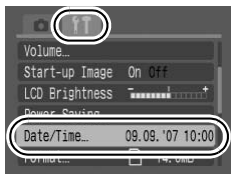

1. Press the power button.

2. Select [Date/Time].

1. Press the  button.
2. Use the  or  button to select the  (Set up) menu.
3. Use the  or  button to select [Date/Time].
4. Press the  button.



3. Select the month, day, year and time, and the display order.

1. Use the  or  button to select an option.
2. Use the  or  button to set the value.
 - You can also set the value by turning the control dial.

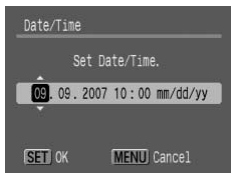

4. Press the  button.

5. Press the  button.









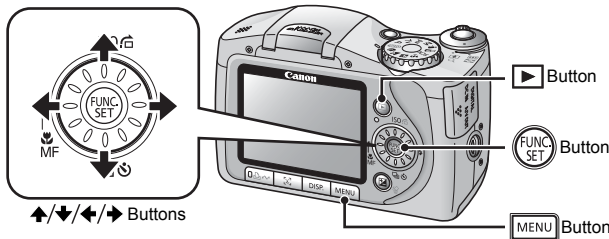

You can imprint the date and time you have set onto images (p. 72).

Setting the Display Language

You can change the language displayed in the LCD monitor menus and messages.



1. Press the  (Playback) button.
2. Hold down the  button and press the  button.
3. Use the , ,  or  button to select a language.
4. Press the  button.

Shooting Still Images (AUTO Mode)

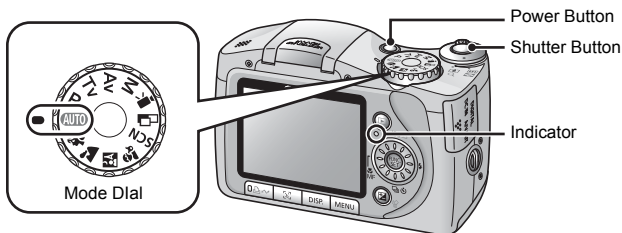

1. Press the power button.

- The start-up sound will play and the start-up image will display in the LCD monitor.
- Pressing the power button again turns the power off.

2. Select a shooting mode.

1. Set the mode dial to **AUTO**.

3. Aim the camera at the subject.



4. Press the shutter button halfway to set the focus.

- When the camera focuses, it beeps twice and the indicator lights green (orange when the flash will fire).
- If  blinks red, we recommend shooting with a flash (p. 65) (the message “Raise the flash” also appears in **AUTO** mode).
- An AF frame will display in green on the LCD monitor at the point of focus.

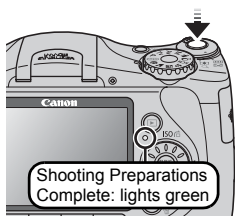

AF Frame

5. Press the shutter button fully to shoot.

- The shutter sound will play once and the image will record.
- The indicator will blink green and the file will record to the memory card.

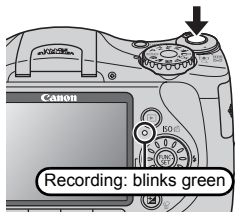

Mute Setting

Pressing the **DISP.** button while switching on the camera power will set the mute setting to [On] to silence all camera sounds except for warning sounds. The setting can be changed with the [Mute] option in the Set up menu (p. 48).

Reviewing an Image Right After Shooting (Rec. Review)

Recorded images are displayed on the LCD monitor for approximately 2 seconds immediately after shooting.

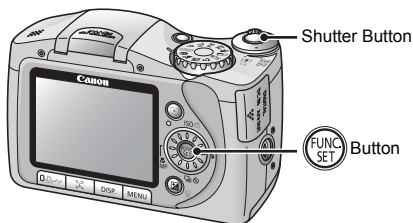

You can also use the following methods to continue displaying the image immediately after shooting so that you can check it.

- Keep the shutter button pressed fully.
- Press the  button while the recorded image is displayed.
 - Confirm the camera beeps once.
You can shoot by pressing the shutter button even when an image is being displayed.

To stop displaying the image, press the shutter button halfway.



Change the image display time with [Review] in the Rec. menu (p. 47).

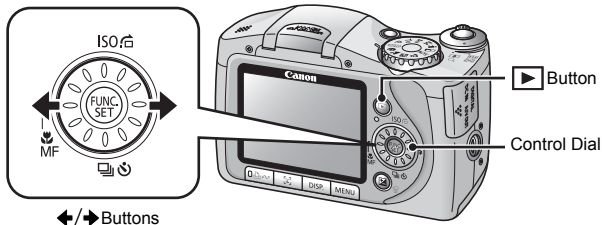

Viewing Still Images



1. Press the (Playback) button.

The last recorded image will display.

2. Use the or button to display the image you wish to view.

- Use the  button to move to the previous image and the  button to move to the next image.
- The images advance more quickly if you keep the button pressed, but they will appear coarse.
- You can also select images by turning the control dial. Turning it counterclockwise displays the previous image while turning it clockwise displays the next image.



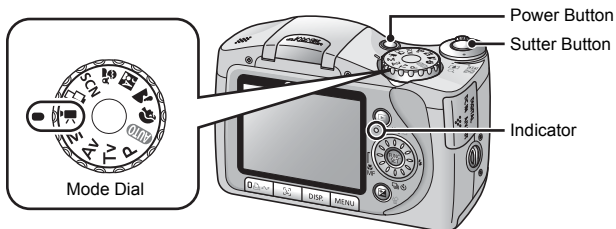

If you have played back images, the last image viewed will display (Resume Playback). If the memory card has been switched, or the images on the memory card have been edited with a computer, the newest image on the memory card appears.

Shooting Movies (Standard Mode)



1. Press the power button.

2. Select a shooting mode.

1. Set the mode dial to  (Movie).
2. Confirm that the camera is set to  (Standard).



3. Aim the camera at the subject.



- Do not touch the microphone while recording.
- Do not press any buttons other than the shutter button. The sound that buttons make will be recorded in the movie.



4. Press the shutter button halfway to set the focus.

- The camera will beep twice and the indicator will light green when the camera focuses.
- The exposure, focus and white balance are automatically set when you press the button halfway.



5. Press the shutter button fully to shoot.

- Recording starts.
- During the recording, the elapsed recording time and [●Rec.] will display in the LCD monitor.

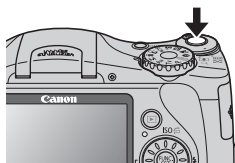

Elapsed Time

6. Press the shutter button fully again to stop recording.

- The indicator will blink green and the data will be recorded onto the memory card.
- Recording will stop automatically when the maximum recording time elapses, or the built-in memory or memory card become full.

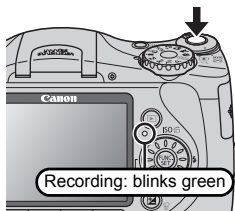

Viewing Movies

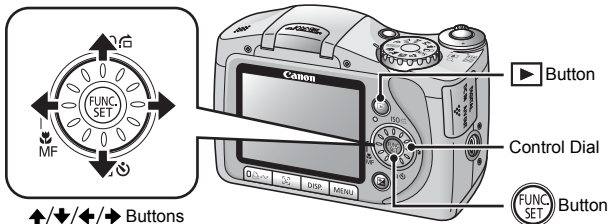



1. Press the  (Playback) button.

2. Use the  or  button to display a movie and press the  button.

- Images with a  icon are movies.
- You can also select an image by turning the control dial.



3. Use the  or  button to select  (Play) and press the  button.

- The movie will start playing.
- If you press the **FUNC./SET** button during playback, you can pause and restart the movie.
- You can adjust the playback volume with the  or  button.



Erasing

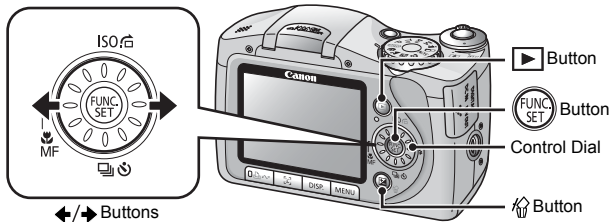

1. Press the (Playback) button.
2. Use the or button to select an image to erase and press the button.

You can also select an image by turning the control dial.

3. Confirm that [Erase] is selected and press the button.

- To exit instead of erasing, select [Cancel].



Please note that erased images cannot be recovered. Exercise adequate caution before erasing an image.

Printing

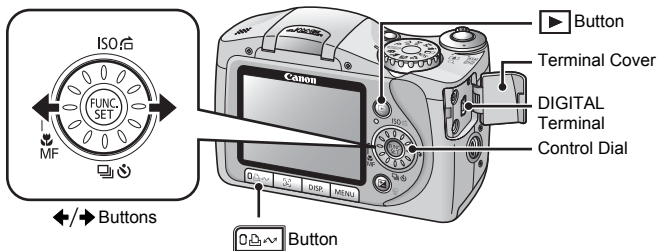

1. Connect the camera to a direct print compatible printer*1.

- Slide the camera's terminal cover to the left to open and insert the interface cable all the way into the terminal.
- See the printer's user guide for connection instructions.

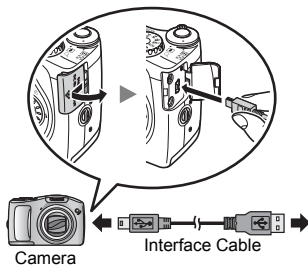

Canon Brand Printers

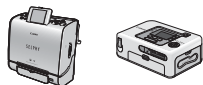

SELPHY Series Compact Photo Printers*2







PIXMA Series Bubble Jet Printers

*1 Since this camera uses a standard protocol (PictBridge), you can use it with other PictBridge-compliant printers in addition to Canon-brand printers.

*2 You can also use the CP-10/CP-100/CP-200/CP-300.

2. Turn on the printer.

3. Press the camera's (Playback) button to turn on the camera.

- The  button will light blue.
- A ,  or  icon will appear in the LCD monitor if the connection is correct (the displayed icons differ according to the connected printer).
-  will display on movies.



4. Use the or button to select an image to print and press the button.

- The  button will blink blue and printing will start.
- You can also select an image by turning the control dial.

After you finish printing, turn off the camera and the printer and disconnect the interface cable.



Always grasp the sides of the connector when disconnecting the interface cable from the camera's DIGITAL terminal.

Downloading Images to a Computer

Items to Prepare

- Camera and computer
- Canon Digital Camera Solution Disk supplied with the camera
- Interface cable supplied with the camera (Be sure to use only the supplied cable)

System Requirements

Please install the software on a computer meeting the following minimum requirements.

■ Windows

OS	Windows Vista Windows XP Service Pack 2 Windows 2000 Service Pack 4
Computer Model	The above OS should be pre-installed on computers with built-in USB ports.
CPU	Windows Vista : Pentium 1.3 GHz or higher Windows XP/Windows 2000 : Pentium 500 MHz or higher
RAM	Windows Vista : 512 MB or more Windows XP/Windows 2000 : 256 MB or more
Interface	USB
Free Hard Disk Space	<ul style="list-style-type: none"> • Canon Utilities <ul style="list-style-type: none"> - ZoomBrowser EX : 200 MB or more - PhotoStitch : 40 MB or more • Canon Camera TWAIN Driver : 25 MB or more
Display	1,024 × 768 pixels/High Color (16 bit) or better

■ Macintosh

OS	Mac OS X (v10.3–v10.4)
Computer Model	The above OS should be pre-installed on computers with built-in USB ports.
CPU	PowerPC G3/G4/G5 or Intel Processor
RAM	256 MB or more
Interface	USB
Free Hard Disk Space	<ul style="list-style-type: none"> • Canon Utilities <ul style="list-style-type: none"> - ImageBrowser : 300 MB or more - PhotoStitch : 50 MB or more
Display	1,024 × 768 pixels/32,000 Colors or better

Preparing to Download Images

Ensure that you install the software first before connecting the camera to the computer.

1. Installing the software.

■ Windows

1. Place the Canon Digital Camera Solution Disk in the computer's CD-ROM drive.

2. Click [Easy Installation].

Follow the onscreen messages to proceed with the installation.



3. Click [Restart] or [Finish] once the installation is complete.

When the installation is finished, [Restart] or [Finish] will display. Click the button that appears.

4. Remove the CD-ROM from the drive when your normal desktop screen appears.



■ Macintosh

Double-click the  icon in the CD-ROM window. When the installer panel appears, click [Install]. Follow the onscreen instructions to proceed.



2. Connecting the camera to a computer.

1. Connect the supplied interface cable to the computer's USB port and to the camera's DIGITAL terminal.

Slide the camera's terminal cover to the left to open and insert the interface cable all the way into the connector.

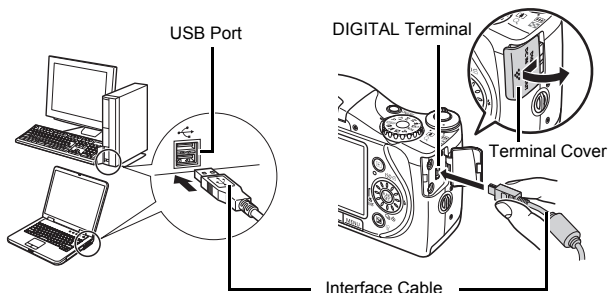

3. Preparing to download images to the computer.

1. Press the (Playback) button to turn on the camera.

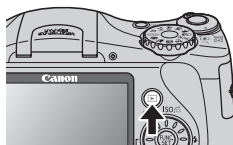

Always grasp the sides of the connector when disconnecting the interface cable from the camera's DIGITAL terminal.



If the Digital Signature Not Found window appears, click [Yes]. The USB driver will automatically finish installing onto the computer when you attach the camera and open a connection.

■ Windows

Select [Canon CameraWindow] and click [OK] (first time only).

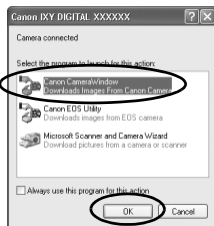

If the window above does not appear, click the [Start] menu and select [All Programs] or [Programs], followed by [Canon Utilities], [CameraWindow], [CameraWindow] and [CameraWindow].

CameraWindow will display.



Preparations for downloading images are now finished. Please proceed to the *Downloading Images Using the Camera* section (p. 29) (except Windows 2000).



With Windows 2000, you can download images using the computer. Please refer to the *Software Starter Guide* for details.

■ Macintosh

The following camera window will appear when you establish a connection between the camera and computer. If it fails to appear, click the [CameraWindow] icon on the Dock (the bar which appears at the bottom of the desktop).



Preparations for downloading images are now finished. Please proceed to the *Downloading Images Using the Camera (Direct Transfer)* section (p. 29).







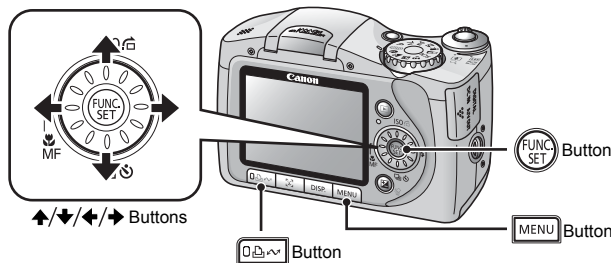

Refer to the *Software Starter Guide* for instructions on downloading images.

Downloading Images Using the Camera (Direct Transfer)

Install the software before downloading images via the direct transfer method for the first time (p. 25).

Use this method to download images using camera operations.
(Except Windows 2000)



	All Images	Transfers and saves all images to the computer.
	New Images	Transfers and saves to the computer only the images that have not been previously transferred.
	DPOF Trans. Images	Transfers and saves to the computer only the images with DPOF Transfer Order settings.
	Select & Transfer	Transfers and saves single images to the computer as you view and select them.
	Wallpaper	Transfers and saves single images to the computer as you view and select them. The transferred images display as the background on the computer desktop.

1. Confirm that the Direct Transfer menu is displayed on the camera's LCD monitor.

- The  button will light blue.
- Press the **MENU** button if the Direct Transfer menu fails to appear.

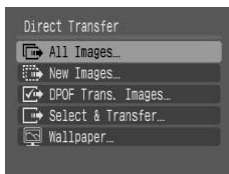

Direct Transfer Menu

■ All Images/New Images/DPOF Trans. Images

2. Use the \uparrow or \downarrow button to select , or and press the button.

- The images will download. The  button will blink blue while downloading is in progress.
- The display will return to the Direct Transfer menu when the download is complete.
- To cancel the download, press the **FUNC./SET** button.



■ Select & Transfer/Wallpaper

2. Use the \uparrow or \downarrow button to select or and press the button.

3. Use the \leftarrow or \rightarrow button to select images to download and press the button.

- The images will download. The  button will blink blue while downloading is in progress.
- Pressing the **FUNC./SET** button will cancel a download in progress.



4. Press the button after downloading finishes.

You will return to the Direct Transfer menu.



Only JPEG images can be selected for downloading as wallpaper for a computer.



The option selected with the  button is retained even when the camera's power is turned off. The previous setting will be in effect the next time the Direct Transfer menu is displayed. The image selection screen will appear directly when the [Select & Transfer] or the [Wallpaper] option was last selected.

Click [×] at the bottom right of the window to close the CameraWindow and the downloaded images will display on the computer.

■ Windows

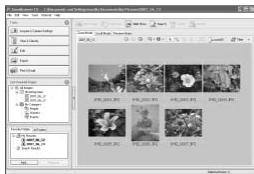

ZoomBrowser EX

■ Macintosh



ImageBrowser

Under default settings, images downloaded to your computer are stored to folder according to date of shooting.

System Map

Supplied with Camera

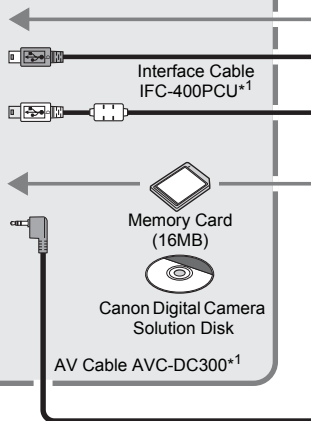
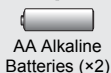
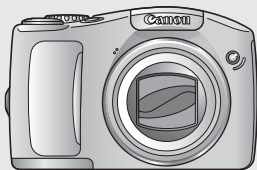

Battery and Charger Kit CBK4-300*5

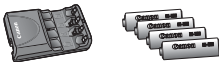

- Battery Charger CB-5AH/
CB-5AHE
- AA-size NiMH batteries
NB-3AH (x4)
- NiMH Battery NB4-300
(set of 4 AA-size)
also available separately.
- Two batteries are used for
this camera.

AC Adapter Kit ACK800

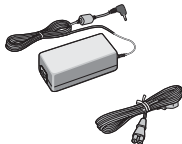

- Compact Power Adapter
CA-PS800
- Power Cord

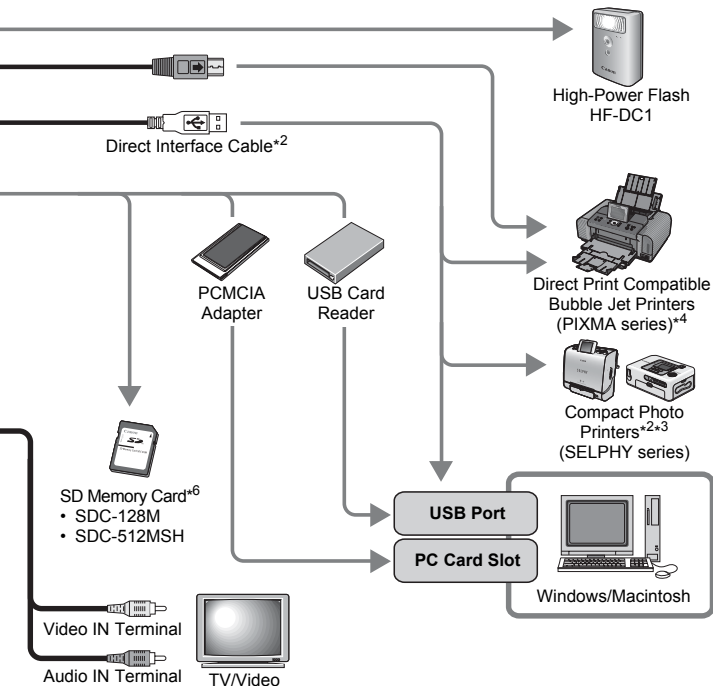

*1 Also available for purchase separately.

*2 See the user guide supplied with the printer for more information on the printer.

*3 This camera can also be connected to the CP-10/CP-100/CP-200/CP-300.

*4 See the user guide supplied with the Bubble Jet printer for more information on the printer and interface cables.

*5 Battery and Charger Kit CBK4-200 can also be used.

*6 Not sold in some regions.

Optional Accessories

The following camera accessories are sold separately.

Some accessories are not sold in some regions, or may no longer be available.

■ Flash

- **High-Power Flash HF-DC1**

This supplementary flash can be attached to your camera when a photographic subject is too distant for the built-in flash to illuminate.

■ Power Supplies

- **AC Adapter Kit ACK800**

This kit lets you power the camera from any standard household power outlet. Recommended to power a camera for an extended period of time or when connecting to a computer.

- **Battery and Charger Kit CBK4-300**

This dedicated battery charger kit includes both a charger unit and four rechargeable AA-size NiMH (nickel metal hydride) batteries. Convenient when taking or playing back large numbers of images.

- **NiMH Battery NB4-300**

A set of four rechargeable AA-size NiMH batteries.
(Two batteries are used for this camera.)

■ Other Accessories

• SD Memory Card

SD memory cards are used to store images recorded by the camera. Canon brand cards are available in 128 MB and 512 MB capacities.

• Interface Cable IFC-400PCU

Use this cable to connect the camera to a computer, Compact Photo Printer (SELPHY series), or to a Bubble Jet printer (refer to your Bubble Jet printer user guide).

• AV Cable AVC-DC300

Use this cable to connect the camera to a TV set.

Direct Print Compatible Printers

Canon offers the following separately sold printers for use with the camera. You can produce photo quality prints quickly and easily by connecting them to the camera with a single cable and operating the camera's controls.

• Compact Photo Printers (SELPHY series)

• Bubble Jet Printers (PIXMA series)

For more information, visit your nearest Canon retailer.

Use of genuine Canon accessories is recommended.

This product is designed to achieve excellent performance when used with genuine Canon accessories. Canon shall not be liable for any damage to this product and/or accidents such as fire, etc., caused by the malfunction of non-genuine Canon accessories (e.g., a leakage and/or explosion of a battery pack). Please note that this warranty does not apply to repairs arising out of the malfunction of non-genuine Canon accessories, although you may request such repairs on a chargeable basis.

Learning More

Components Guide

■ Front View

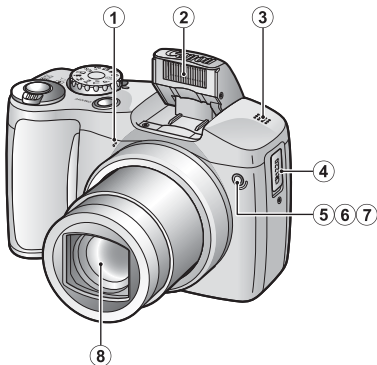

- ① Microphone (p. 150)
- ② Flash (p. 65)
- ③ Speaker
- ④ Date Battery Holder (p. 191)
- ⑤ AF-assist Beam (p. 47)
- ⑥ Red-Eye Reduction Lamp (p. 93)
- ⑦ Self-Timer Lamp (p. 67)
- ⑧ Lens

■ Back View

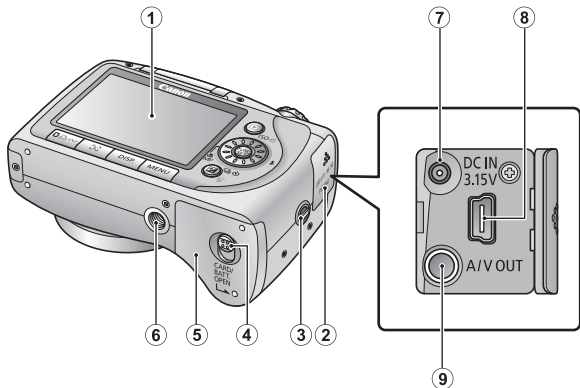

- ① LCD Monitor (p. 51)
- ② Terminal Cover
- ③ Wrist Strap Mount (p. 9)
- ④ Battery Cover Lock (pp. 8, 10)
- ⑤ Memory Card Slot / Battery Cover (pp. 8, 10)
- ⑥ Tripod Socket
- ⑦ DC IN (Power Input) Terminal (p. 188)
- ⑧ DIGITAL Terminal (p. 26)
- ⑨ A/V OUT (Audio/Video output) Terminal (p. 161)



The LCD monitor may be covered with a thin plastic film for protection against scratches during shipment. If so, remove the film before using the camera.

■ Controls

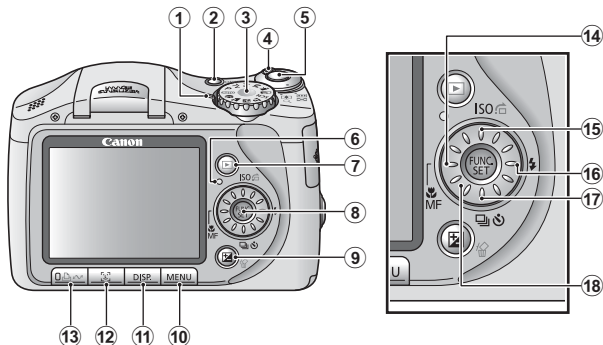

- ① Power Lamp
- ② Power Button (p. 12)
- ③ Mode Dial (pp. 14, 18)
- ④ Zoom Lever
(pp. 60, 133, 134)
Shooting: (Wide Angle)/
 (Telephoto)
Playback: (Index)/
 (Magnify)
- ⑤ Shutter Button (p. 15)
- ⑥ Indicator (p. 43)
- ⑦ (Playback) Button (p. 17)
- ⑧ **FUNC./SET** (Function/Set) Button (p. 44)
- ⑨ (Exposure)/ (Single Image Erase) Button (pp. 114, 21)
- ⑩ **MENU** Button (p. 45)
- ⑪ **DISP.** Button (p. 51)
- ⑫ (Face Selector) Button (p. 101)
- ⑬ (Print/Share) Button (pp. 22, 29, 154)
- ⑭ (Macro)/ **MF** (Manual Focus)/ Button (pp. 66, 105)
- ⑮ **ISO**/ (Jump)/ Button (pp. 110, 138)
- ⑯ (Flash)/ Button (p. 65)
- ⑰ (Continuous)/
 (Selftimer)/ Button (pp. 91, 67)
- ⑱ Control Dial (p. 41)

Using the Control Dial

Turning the control dial counterclockwise is equivalent to pressing the ◀ button, while turning the control dial clockwise is equivalent to pressing the ▶ button (it is equivalent to pressing the ▲ or ▼ button with some functions).

You can perform the following operations when you turn the control dial.

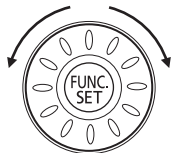

When this arrow is displayed, operation is carried out using the control dial.

■ The Shooting Functions

- Selecting Special Scene modes (p. 75)
- Selecting ⚡/🌸/🕒/📷/ISO (pp. 65 – 67, 91, 110)
- Selecting the FUNC. menu item (p. 46)
- Selecting the movie mode (p. 79)
- Selecting the shooting direction in Stitch Assist mode (p. 83)
- Selecting a shutter speed in **Tv** (p. 86)
- Selecting an aperture value in **Av** (p. 88)
- Selecting the shutter speed and the aperture value in **M** (p. 90)
- Moving the AF frame in Face Detect mode (p. 101)
- Adjusting the focus in manual focus mode (p. 105)
- Adjusting the exposure (p. 114)

■ The Playback Functions

- Selecting an image in playback mode (pp. 17, 133, 134, 138, 144, 149)
- Operating when viewing movies (p. 139)
- Operating the sound memos (p. 150)
- Operating DPOF print settings and transfer settings (pp. 154, 159)

■ The Shooting and Playback Functions

- Selecting a menu item (pp. 44, 45)

▶ Button

▶ You can turn the camera on or off and switch between shooting mode and playback mode.

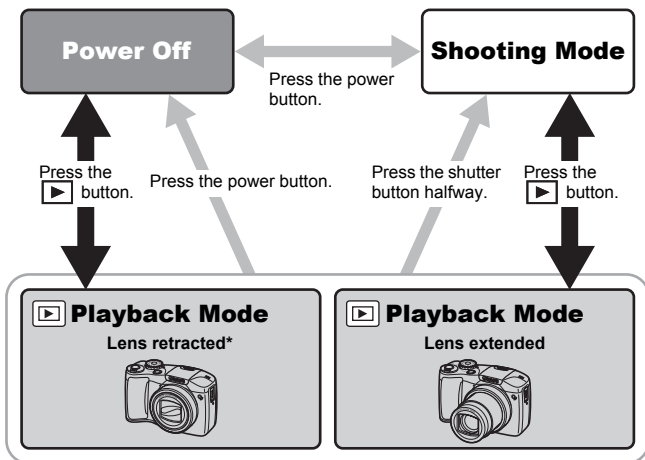
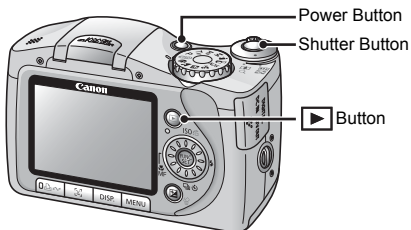

* You can change the lens retraction timing in [Lens Retract] in the (Set up) menu (p. 49).

Indicators

The indicators on the back of the camera will light or blink under the following conditions.

Green: Ready to shoot (camera beeps twice*)

Blinking Green: Image recording/reading/erasing/transferring (when connected to a computer)

Orange: Ready to shoot (flash on)

Blinking Orange: Ready to shoot (camera shake warning)

* When the camera focuses difficultly, it beeps once.



Never do the following while the indicator blinks green. These actions may corrupt image data.

- Shake or jolt the camera
- Shut off the power, or open the memory card slot/battery cover

Power Saving Function

This camera is equipped with a power saving function. The power will shut off in the following circumstances. Press the power button again to restore power.

Shooting Mode	Powers down approximately 3 minutes after the last control is accessed on the camera. The LCD monitor automatically turns off 1 minute* after the last control is accessed even if [Auto Power Down] is set to [Off]. (Press any button other than the power button or change the camera orientation to turn the LCD monitor back on.)
Playback Mode Connected to a Printer	Powers down approximately 5 minutes after the last control is accessed on the camera.

* This time can be changed.



- The power saving function will not activate during an Auto Play or while the camera is connected to a computer.
- The power saving function settings can be changed (p. 49).

Basic Operations



Menus and Settings

Settings for the shooting or playback modes or such camera settings as the print settings, date/time and sounds are set using the FUNC. menu or the Rec., Play, Print or Set up menu.

■ Button (FUNC. Menu)

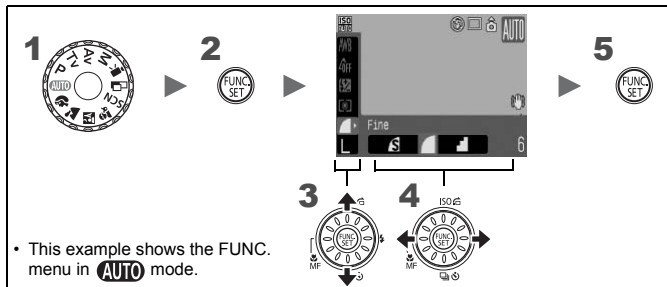
This menu sets many of the common shooting functions.



- 1** Set the mode dial to the shooting mode you want to use.
- 2** Press the  button.
- 3** Use the **↑** or **↓** button to select a menu item.
 - Some items may not be selectable in some shooting modes.
- 4** Use the **←** or **→** button to select an option for the menu item.
 - You can change the settings for options indicated with **DISP.** using the **DISP.** Button.
 - After selecting an option, you can press the shutter button to shoot immediately. After shooting, this menu will appear again, allowing you to adjust the settings easily.
 - You can also use the control dial to select an option for the menu item.
- 5** Press the  button.

■ **MENU** Button (Rec., Play, Print and Set up Menus)

Convenient settings for shooting, playback or printing can be set with these menus.

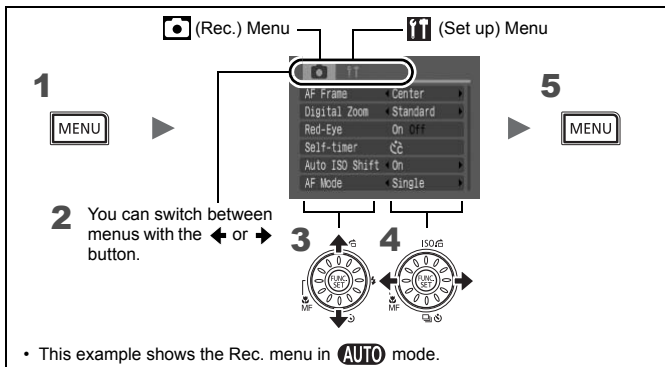

1 Press the **MENU** button.

2 Use the ← or → button to switch between menus.

- You can also use the zoom lever to switch between menus.
- The following menus are displayed.
 - Shooting: Rec. / Set up
 - Playback: Play / Print / Set up

3 Use the ↑ or ↓ button to select a menu item.

- Some items may not be selectable in some shooting modes.
- You can also use the control dial to select a menu item.

4 Use the ← or → button to select an option.

Menu items followed by an ellipsis (...) can only be set after pressing the **FUNC./SET** button to display the next menu. Press the **FUNC./SET** button again to confirm the setting, then press the **MENU** button to return to the menu screen.







5 Press the **MENU** button.

Menus and Default Settings

See *Functions Available in Each Shooting Mode*.

FUNC. Menu







The icons shown here indicate the default settings (factory settings).

Menu Item		Reference Page	Menu Item		Reference Page
	White Balance	p. 116		Compression (Still image)	p. 70
	My Colors	p. 119		Recording Pixels (Still image)	p. 69
	+/- (Flash) / Flash Output	p. 121		Recording Pixels (Movie)	p. 82
	Metering Mode	p. 115			









Rec. Menu

*Default setting

Menu Item	Options	Contents/ Reference Page
AF Frame	Face Detect*/Center (The default setting is Center in P , Tv , Av and M modes.)	p. 98
AF Frame Size	Normal*/Small	p. 100
Digital Zoom		
(Still image)	Standard*/Off/1.6x/2.0x	p. 61
(Movie)	Standard*/Off (In standard movie mode only)	
Slow Synchro	On/Off*	p. 94
Flash Adjust	Auto*/Manual	p. 121
Red-Eye	On*/Off	p. 93
Safety FE	On*/Off	p. 124

Menu Item	Options	Contents/ Reference Page
Self-timer		
Delay	0 – 10*, 15, 20, 30 sec.	p. 67
Shots	1 – 10 (Default is 3 shots)	
Safety Shift	On/Off*	p. 89
Auto ISO Shift	 Button/On/Off*	p. 111
MF-Point Zoom	On*/Off	p. 105
Safety MF	On*/Off	p. 106
AF Mode	Continuous/Single*	p. 97
AF-assist Beam	On*/Off	p. 38
Review	Off/2*–10 seconds/Hold	You can set the length of time images display after being shot (p. 16).
Review Info	Off*/Detailed/Focus Check	p. 95
Disp. Overlay		
(Still image)	Off*/Grid Lines/3:2 Guide/Both	p. 127
(Movie)	Off*/Grid Lines	
IS Mode		
(Still image)	Continuous*/Shoot Only/ Panning/Off	p. 73
(Movie)	Continuous*/Off	
Date Stamp	Off*/Date/Date & Time	p. 72
Set  button	 */WB/  /T/  / 	p. 125

Play Menu

Menu Item	Reference Page
 Auto Play	p. 143
 Red-Eye Correction	p. 144
 Resize	p. 149
 Sound Memo	p. 150
 Protect	p. 152
 Rotate	p. 141
 Erase all	p. 153
 Transfer Order	p. 159
 Transition	p. 142

Print Menu

Menu Item	Reference Page
Print	p. 154
Select Image & Qty.	
Select All Images	
Clear All Selections	
Print Settings	

Set up Menu



*Default setting

Menu Item	Options	Contents/Reference Page
Mute	On/Off*	Set to [On] to silence all operation sounds except for the warning sounds.
Volume	Off/1/2*/3/4/5	Adjusts the volume of the start-up sound, operation sound, self-timer sound, shutter sound and playback sound. The volume cannot be adjusted if [Mute] is set to [On].
Start-up Vol.		Adjusts the volume of the start-up sound when the camera is turned on.
Operation Vol.		Adjusts the volume of the operation sound that beeps when any button other than the shutter button is pressed.
Selftimer Vol.		Adjusts the volume of the self-timer sound played 2 sec. before the shutter is released.
Shutter Volume		Adjusts the volume of the sound played when the shutter releases. The shutter sound does not play when a movie is recording.

Menu Item	Options	Contents/Reference Page
Playback Vol.		Adjusts the playback volume of movies and sound memos.
Start-up Image	On*/Off	Sets whether or not the Start-up Image appears when the camera is powered on.
LCD Brightness	-7 to 0* to +7	Use the ◀ or ▶ button to adjust the brightness. You can check the brightness while you are adjusting the setting.
Power Saving		p. 43
Auto Power Down	On*/Off	Sets whether or not the camera automatically powers down after a set period of time elapses without the camera being operated.
Display Off	10 sec./20 sec./ 30 sec./1 min.*/ 2 min./3 min.	Sets the length of time before the LCD monitor turns off when no camera operation is performed.
Date/Time		p. 12
Format		You can also select a low level format (p. 59).
File Numbering	Continuous*/ Auto Reset	p. 131
Create Folder		p. 129
Create New Folder	Check mark (On)/ No check mark (Off)	Creates a folder during the next shooting session.
Auto Create	Off*/Daily/ Monday-Sunday/ Monthly	You can also set an auto creation time.
Auto Rotate	On*/Off	p. 128
Distance Units	m / cm* / ft / in	Sets the units for the zoom bar and MF indicator distance unit (p. 105).
Lens Retract	1 minute*/ 0 seconds	Sets the lens retraction timing when switching from shooting mode to playback mode.

Menu Item	Options	Contents/Reference Page
Language		p. 13
Video System	NTSC/PAL	p. 161
Print Method	Auto*/ 	See below.
Reset All		p. 58

Print Method

The connection method with the printer can be changed for printing. Although it is normally not necessary to change the setting, select  when borderless printing an image shot in  (Widescreen) mode on wide size paper using Canon compact photo printer SELPHY CP750/CP740/CP730/CP720/CP710/CP510. As this setting will be stored to memory even when the power is turned off, to print using an image size other than , return the mode to [Auto] (however, the connection method cannot be changed while connected to a printer).

Using the LCD Monitor

1 Press the **DISP.** button.

- The display mode changes as follows with each press.

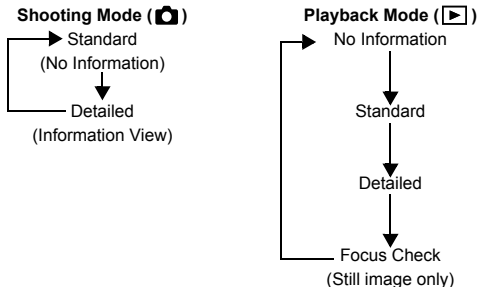

- The shooting information displays for approximately 6 sec. when a setting is changed, regardless of the selected display mode.



The LCD monitor will not switch to the Detailed display or Focus Check display while in Magnified display (p. 133) or index playback (p. 134) mode.

LCD Monitor Brightness

The brightness of the LCD monitor can be changed in the following two ways.

- **Changing settings using the Set up menu (p. 48)**
- **Changing settings using the Quick-bright LCD function**

You can set the LCD monitor to the brightest setting regardless of the option selected in the Set up menu by pressing the **DISP.** button for more than one second*.

- To restore the previous brightness setting, press the **DISP.** button for more than one second again.
- The next time you turn on the camera, the LCD monitor will be at the brightness setting selected in the Set up menu.

* You cannot change the brightness of the LCD monitor with this function if you have already set it to its highest setting in the Set up menu.

Night Display

When shooting at dusk or during the evening when the dark surroundings make it difficult to view the LCD monitor, the camera's "night view" option* displays the subject brightly in the LCD monitor. This will allow you to compose a shot even in dark environments (this setting cannot be turned off).







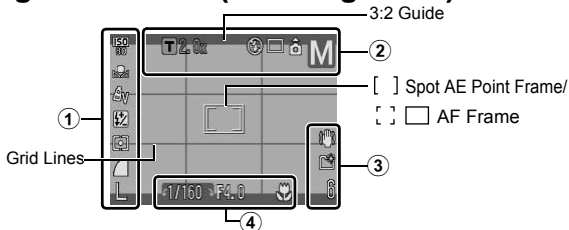

* Although noise may appear and the movement of the subject shown on the LCD monitor may appear somewhat jagged, there is no effect on the recorded image. The brightness of the image displayed in the monitor, and the brightness of the actual image recorded will be different.

Information Displayed on the LCD Monitor

Shooting Information (Shooting Mode)





	ISO Speed	ISO AUTO ISO F11 ISO 80 ISO 100 ISO 200 ISO 400 ISO 800 ISO 1600 (ISO 80 ... ISO1600)*	p. 110
	White Balance		p. 116
	My Colors		p. 119
①	Flash Exposure Compensation/Flash Output		p. 121
	Metering Mode		p. 115
	Compression (Still image)		p. 70
	Recording Pixels (Still image)	L M1 M2 M3 S	p. 69
	Recording Pixels (Movies)	640 64P 320 160	p. 82
	Digital Tele-Converter/ Safety Zoom	T 1.6x/2.0x 	p. 61
	Flash		p. 65
	Drive Mode		pp. 91, 67
	Auto Rotate		p. 128
②	Shooting Mode		p. 75
	Low Battery	(Red)	p. 182
	Movie Recording	[● Rec.] (Red)	pp. 18, 79
	Zoom Bar		pp. 60, 62
	MF Indicator		p. 105

	Image Stabilizer		p. 73
	Create Folder		p. 129
③	Stills: Recordable Shots Movies: Remaining Time/Elapsed Time		pp. 199, 200
	Camera Shake Warning	 (Red)*	p. 18
	AE Lock/FE Lock		pp. 107, 109
	Shutter Speed	15 – 1/2500*	pp. 86, 90
	Aperture Value	f/2.8 – f/11*	pp. 88, 90
④	Exposure Shift Bar		p. 81
	Exposure Compensation		p. 114
	AF Lock/Manual Focus		pp. 104, 105
	Macro		p. 66

* Displays when the shutter button is pressed halfway. During flash photography, however, the camera automatically readjusts the ISO speed, shutter speed or aperture setting to an optimal setting, which may cause the playback information to differ from the displayed information.



If the indicator blinks orange and  is displayed, this indicates that a slow shutter speed may have been selected due to insufficient illumination. Use the following methods to shoot:

- Set the IS mode to any setting other than [Off] (p. 73)
- Raise the ISO speed (p. 110)
- Set the Auto ISO Shift to any setting other than [Off] (p. 111)
- Raise the flash to enable  or  (p. 65)
- Attach the camera to a tripod or other device

Playback Information (Playback Mode)

■ Standard



	Displayed image number/Total number of images	—
①	Folder Number-File Number	pp. 129, 131
	Low Battery	(Red) p. 182
	Compression (Still Images)	p. 70
	Recording Pixels (Still Images)	p. 69
	Movie	p. 17
②	Red-Eye Corrected/Resized	pp. 144, 149
	WAVE Format Sound	p. 150
	Protection Status	p. 152
	Shooting Date/Time	—

■ Detailed



Histogram (p. 57)

①	Shooting Mode	p. 75
---	---------------	-------

Recording Pixels/ Frame Rate (Movies)		p. 82
Metering Mode		p. 115
ISO Speed	ISO 80 ... ISO1600	p. 110
Shutter Speed	15 – 1/2500	pp. 86, 90
Aperture Value	f/2.8 – f/11	pp. 88, 90
Exposure Compensation	-2 ... +2	p. 114
Flash Exposure Compensation	-2 ... +2	p. 121
① Flash Output		p. 123
White Balance	AWB	p. 116
My Colors		p. 119
Red-Eye Correction Function		p. 144
AF Lock/Manual Focus		pp. 104, 105
Macro		p. 66
File size Recording Pixels (Still Image) Movie Length (Movies)		pp. 199, 200

■ Focus Check Display







① Folder Number-File Number		-
② Compression (Still Images)		p. 70
Recording Pixels (Still Images)		p. 69



The Focus Check display cannot be selected for movies.

The following information may also be displayed with some images.

	A sound file in a format other than the WAVE format is attached or the file format is not recognized.
	JPEG image not conforming to Design rule for Camera File System Standards.
	RAW image
	Image recording pixel setting not recognized



- Information for images shot on other cameras may not display correctly.
- Overexposure Warning
In the following cases, overexposed portions of the image blink.
 - When reviewing an image right after shooting in the LCD monitor (information view)
 - When using the detailed display mode of the playback mode

Histogram Function

The histogram is a graph that allows you to check the brightness of the image. The greater the bias toward the left in the graph, the darker the image. The greater the bias toward the right, the brighter the image. If the image is too dark, adjust the exposure compensation to a positive value. Similarly, adjust the exposure compensation to a negative value if the image is too bright (p. 114).

Sample Histograms



Dark Image



Balanced Image

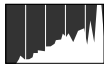

Bright Image

Resetting Settings to Their Default Values



1 Select [Reset All].

1. Press the **MENU** button.
2. Use the **←** or **→** button to select the **ff** menu.
3. Use the **↑** or **↓** button to select [Reset All].
4. Press the **FUNC. SET** button.



2 Accept the setting.

1. Use the **←** or **→** button to select [OK].
2. Press the **FUNC. SET** button.



- Settings cannot be reset when the camera is connected to a computer or to a printer.
- The following cannot be reset.
 - Shooting mode
 - The [Date/Time], [Language] and [Video System] options in the **ff** menu (pp. 49, 50)
 - White balance data recorded with the custom white balance function (p. 117)

Formatting Memory Cards



You should always format a new memory card or one from which you wish to erase all images and other data.



Please note that formatting (initializing) a memory card erases all data, including protected images and other file types.

1 Select [Format].

1. Press the button.
2. Use the or button to select the menu.
3. Use the or button to select [Format].
4. Press the button.

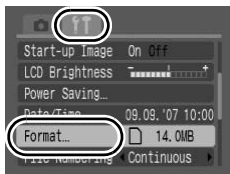

2 Accept the setting.

1. Use the or button to select [OK].
2. Press the button.
 - To perform a low level format, use the button to select [Low Level Format] and the or button to add a check mark.
 - You can stop formatting a memory card when [Low Level Format] is selected by pressing the **FUNC./SET** button. You can still use a memory card without problem when formatting is halted, but its data will be erased.

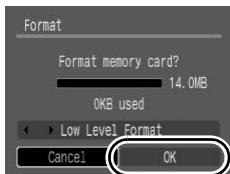

Low Level Format

We recommend you select [Low Level Format] when you think that the recording/reading speed of a memory card has dropped. A low level format may require 2 to 3 minutes with some memory cards.

Commonly Used Shooting Functions

Shooting with the Optical Zoom

 See *Functions Available in Each Shooting Mode* (p. 222).



Shooting Mode

AUTO     SCN   **P** Tv Av M

The zoom can be adjusted from 36 mm – 360 mm (focal length) in 35mm film equivalent terms. The zoom bar will display while you adjust the zoom.

1 **Press the zoom lever toward**

 **or** .

-  **Wide Angle:** Zooms out from the subject.
-  **Telephoto:** Zooms in on the subject.

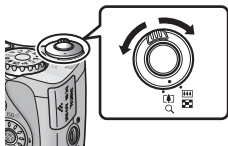

Focus range (rough guide)

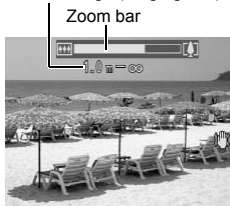

Using the Digital Zoom/ Digital Tele-Converter



See *Functions Available in Each Shooting Mode* (p. 222).

Shooting Mode



* : [Digital Tele-converter] cannot be set.

You can combine digital zoom with optical zoom when shooting. The available shooting characteristics and focal lengths (35mm film equivalent) are as follows:

Selection	Focal Length	Shooting Characteristics
Standard	36 – 1440 mm	Enables shooting at zoom factors of up to 40x with digital and optical zoom combined. The can only be set in the standard mode.
Off	36 – 360 mm	Enables shooting without digital zoom.
1.6x	57.6 – 576 mm	Digital zoom is fixed at the selected zoom factor, and the focal length shifts to maximum telephoto. This enables a faster shutter speed and less chance of camera shake than a shot taken at the same angle of view with [Standard] or [Off].
2.0x	72 – 720 mm	



The digital zoom cannot be used in or (Postcard), or (Widescreen) modes.

Shooting with the Digital Zoom

1 Select [Digital Zoom].

1. Press the button.
2. In the menu, use the or button to select [Digital Zoom].



2 Accept the setting.

1. Use the **←** or **→** button to select [Standard].
2. Press the **MENU** button.





3 Press the zoom lever toward **[Z]** and shoot.

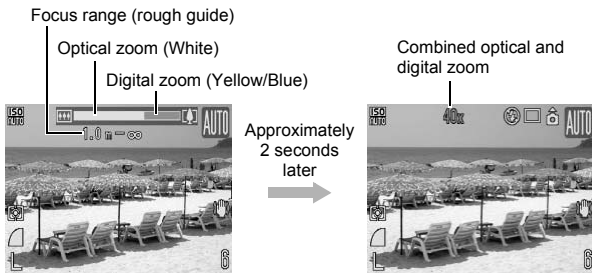



- The combined digital and optical zoom setting will display in the LCD monitor.
- The image may appear coarse depending upon the selected recording pixels. The zoom factor appear in blue (p. 63).
- Press the zoom lever toward **[Z]** to zoom out.



Safety Zoom Zone

- Depending on the number of recording pixels set, you can zoom without pausing up to a factor where the image quality does not deteriorate (Safety Zoom) (except in the movie mode). The  icon displays when reaching the maximum zoom factor without image deterioration. At this point, the image can be further magnified by pressing the zoom lever toward  (telephoto) again.
- Depending on the number of recording pixels set, the Safety Zoom zone varies as follows. The color of the zoom bar on the LCD monitor means as follows:

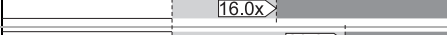
Safety Zoom Factor

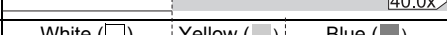
Recording pixels	Optical zoom	Digital zoom	
L (3264×2448)	10.0x		
M1 (2592×1944)	13.0x		
M2 (2048×1536)	16.0x		
M3 (1600×1200)	20.0x		
S (640×480)	40.0x		
The color of the zoom bar	White (□)	Yellow (■)	Blue (■)
	Zone without deterioration		Zone with deterioration

Shooting with the Digital Tele-Converter

The digital tele-converter feature uses digital zoom to achieve the effects of a tele-converter (a lens used in telephoto shooting).

1 Select [Digital Zoom].

1. Press the **MENU** button.
2. In the  menu, use the **↑** or **↓** button to select [Digital Zoom].



2 Accept the setting.

1. Use the **←** or **→** button to select [1.6x] or [2.0x].
2. Press the **MENU** button.

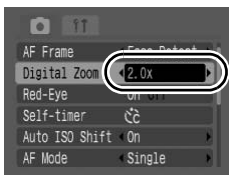

3 Adjust the angle of view with the zoom lever and shoot.

- **T** and the zoom factor will appear on the LCD monitor.
- The image may appear coarse depending upon the selected recording pixels (the **T** icon and the zoom factor appear in blue).



⚡ Using the Flash



➔ See *Functions Available in Each Shooting Mode* (p. 222).

Shooting Mode



* Cannot be set in mode.

1 Raise the flash manually.

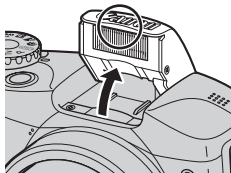

2 Press the ⚡ button.

- Use the ← or → button to change the flash mode.

: [Auto]

: [On]

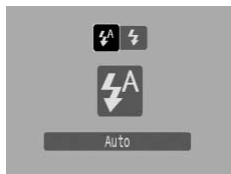

3 When you are not using the flash, lower the flash until it closes.

- (flash off) appears in the LCD monitor.

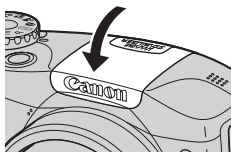

You are recommended to shoot with the camera attached to a tripod or other device if the camera shake warning icon appears.



When the flash recharging begins after shooting, the indicator blinks orange and the LCD monitor turns off. When recharging ends, the indicator turns off and the LCD monitor turns on. The time required for flash recharging will change depending on usage conditions and remaining battery power.

Shooting Close-ups (Macro)

 See *Functions Available in Each Shooting Mode* (p. 222).





Shooting Mode



* Cannot be set in  mode.





Use this mode to shoot close-ups of flowers or small items. The image area at the minimum shooting distance from the end of the lens to the subject (1 cm) is 29 × 21 mm.

1 Press the button.

- Use the  or  button to select .
 - The zoom bar will display while you adjust the zoom. At zoom ranges not possible for macro photography, the bar will appear yellow and the  icon will gray out. Although the shutter button can be pressed at this point, the image will be recorded at standard shooting distances.



To Cancel the Macro Mode:

Press the  button and use the  or  button to select  (Normal).



Using the flash in macro mode may cause image edges to darken.

Using the Self-Timer



➔ See *Functions Available in Each Shooting Mode* (p. 222).

Shooting Mode



* Cannot be set in mode.

You can set the time delay and the numbers of shots you wish to take in advance.

	<p>10 sec. Self-Timer: shoots 10 seconds after you press the shutter button.</p> <ul style="list-style-type: none"> • 2 seconds before the shutter releases, the self-timer lamp and sound speed up.
	<p>2 sec. Self-Timer: shoots 2 seconds after you press the shutter button.</p> <ul style="list-style-type: none"> • The self-timer sound beeps quickly when you press the shutter button and the shutter releases 2 seconds later.
	<p>Custom Timer: you can change the delay time (0 – 10, 15, 20, 30 sec.) and number of shots (1 – 10).</p> <ul style="list-style-type: none"> • When [Delay] is set to 2 or more seconds, the self-timer sound beeps quickly 2 seconds before the shutter releases.

1 Press the button.

1. Use the or button to change the option.

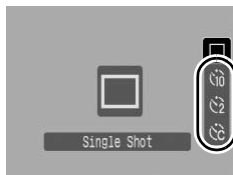

2 Shoot.

- When the shutter button is pressed fully, the self-timer will activate and the self-timer lamp will blink (when using red-eye reduction, it will stay lit for the last 2 seconds).

To Cancel the Self-Timer:

Follow procedure 1 to display .







Changing the Delay Time and Number of Shots (📷)

1 Select [Self-timer].

1. Press the  button.
2. In the  menu, use the  or  button to select [Self-timer].
3. Press the  button.



2 Accept the setting.

1. Use the  or  button to select [Delay] or [Shots] and change the settings with the  or  button.
2. Press the  button.
3. Press the  button.



If the [Shots] option is set to 2 or more shots, the following occurs.

- The exposure and white balance are locked at the settings selected for the first shot.
- If the flash is used, the interval between shots lengthens because the flash must charge.
- The interval between shots may lengthen when the built-in memory of the camera fills.
- Shooting will automatically cease if the memory card becomes full.







Changing the Recording Pixels (Still Images)

 See *Functions Available in Each Shooting Mode* (p. 222).

Shooting Mode



AUTO     **SCN**   **P Tv Av M**

1 Select setting.

1. Press the  button.
2. Use the  or  button to select **L** and the  or  button to change the option.
3. Press the  button.



Approximate Values for Recording Pixels

Recording Pixels				Purpose* ¹
L Large	8M	3264 × 2448	High  Low	Printing to about A3-size 297 × 420 mm (11.7 × 16.5 in.)
M1 Medium 1	5M	2592 × 1944		Printing to about A4-size 210 × 297 mm (8.3 × 11.7 in.) Printing to about Letter-size 216 × 279 mm (8.5 × 11 in.)
M2 Medium 2	3M	2048 × 1536		Printing to about A5-size 148 × 210 mm (6 × 8.3 in.)
M3 Medium 3	2M	1600 × 1200		Print postcard-size prints 148 × 100 mm (6 × 4 in.) Print L-size prints 119 × 89 mm (4.7 × 3.5 in.)
S Small	0.3M	640 × 480		Send images as e-mail attachments or shoot more images
 *2 or  *2 Postcard		1600 × 1200		When printing to postcards (p. 71).
W *2 Widescreen		3264 × 1832	Printing on wide size paper (you can check the composition at a 16:9 aspect ratio. Areas that will not be recorded appear on the LCD monitor as a black border.)	

 : Approximate recording pixel numbers are shown. (M is short for megapixels.)

*1 Paper sizes vary according to region.

*2 Cannot be set in  mode.

Changing the Compression (Still Images)



➔ See *Functions Available in Each Shooting Mode* (p. 222).

Shooting Mode



1 Select a compression setting.

1. Press the button.
2. Use the or button to select and the or button to change the option.
3. Press the button.



Approximate Values for Compression Settings

Compression		Purpose
Superfine	High Quality	Shoot higher quality images
Fine	↕	Shoot normal quality images
Normal	Normal	Shoot more images



- See *Memory Cards and Estimated Capacities* (p. 199).
- See *Image Data Sizes (Estimated)* (p. 200).

Configuring the Postcard Mode









 See *Functions Available in Each Shooting Mode* (p. 222).

Shooting Mode

     SCN   P Tv Av M

You can shoot images with the optimal settings for postcards by composing them inside the print area (width-to-height ratio of approximately 3:2) shown in the LCD monitor.

1 Select .

1. Press the  button.
2. Use the  or  button to select  and choose  with the  or  button.
3. Press the  button.

- The area that will not print displays in gray.
- Approximately 2M recording pixels, and compression settings are fixed to  (Fine).



The digital zoom or the digital tele-converter cannot be used in this mode.



For printing instructions, refer to the *Direct Print User Guide*.

Embedding the Date in the Image Data









 See *Functions Available in Each Shooting Mode* (p. 222).

Shooting Mode

AUTO     **SCN**   **P Tv Av M**

You can embed the date in the image data when  (Postcard) is selected.

1 Select .

1. Press the  button.
2. Use the  or  button to select  and choose  with the  or  button.
3. Press the  button.

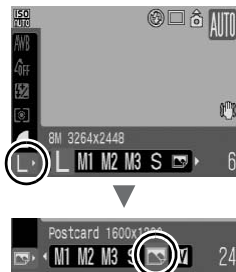





2 Select [Date Stamp].

1. Press the  button.
2. In the  menu, use the  or  button to select [Date Stamp].



3 Set the date and time.

1. Use the  or  button to select [Date] or [Date & Time].
2. Press the  button.
 - LCD Monitor Display
[Off]: 
[Date]/[Date & Time]: 



- Ensure that the camera's date/time is set beforehand (p. 12).
- The date stamp cannot be deleted from the image data once it has been embedded.



To imprint the date on images for all but , use the supplied software (ZoomBrowser EX or ImageBrowser) or printer settings. For details, please see the user guide for each product.

Setting the Image Stabilizer Function



 See *Functions Available in Each Shooting Mode* (p. 222).

Shooting Mode

     SCN   * P Tv Av M

* Can only be set to [Continuous].

The lens shift image stabilizer function allows you to minimize the camera shake effect (blurred images) when you shoot distant subjects that have been magnified or when you shoot in dark conditions without a flash.

Off		Turns off the image stabilizer function.
	Continuous	You can check the effect of the IS mode on image blur on the LCD monitor since the IS mode runs continually. This makes it easier to compose images and focus on subjects.
	Shoot Only	Shoot Only IS mode is only activated when the shutter button is pressed. When set to [Continuous], some blurring may occur depending on the subjects. In Shoot Only mode, subjects can be taken without concern for any unnatural movement that may appear on the LCD monitor.
	Panning	This option only stabilizes the effect of up and down camera motions on the image. This option is recommended for shooting objects moving horizontally.

1 Select [IS Mode].



1. Press the  button.
2. In the  menu, use the  or  button to select [IS Mode].

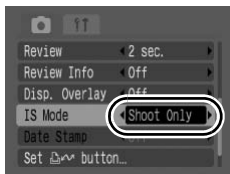

2 Accept the setting.

1. Use the ◀ or ▶ button to select [Continuous], [Shoot Only], [Panning] or [Off].
2. Press the  button.



- Camera shake may not be fully corrected when shooting with slow shutter speeds, such as with evening shots. Switch the Auto ISO Shift (p. 111) to a setting other than [Off], or use a tripod to shoot.
- If camera shake is too strong, it may not be fully corrected.
- Hold the camera horizontally while panning (stabilization does not work when the camera is held vertically).
- If you select [Shoot Only] or [Panning] in shooting mode (still images) and then switch to  mode, the setting will change to [Continuous]. (If you further switch to a different shooting mode from , the settings will change back to the original condition.)

Shooting Using the Mode Dial

Mode Dial

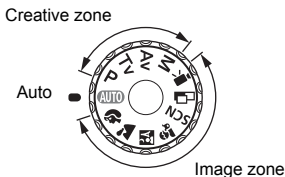

■ Auto

AUTO The camera automatically selects settings (p. 14).

■ Image zone

When a shooting mode appropriate for the shooting conditions is selected, the camera automatically adjusts settings for optimal shooting (p. 76).



: Portrait



: Landscape



: Night Snapshot



: Kids&Pets

SCN : Special Scene (p. 76)



: Night Scene



: Indoor



: Foliage



: Snow



: Beach



: Fireworks



: Aquarium



: Stitch Assist (p. 83)



: Movie (Standard/Compact) (pp. 18, 79)

■ Creative zone

With these settings, you select parameters such as the shutter speed or aperture stop to achieve a range of effects.

P

: Program AE (p. 85)

Tv

: Setting the Shutter Speed (p. 86)

Av

: Setting the Aperture (p. 88)

M

: Manually Setting the Shutter Speed and Aperture (p. 90)

Shooting Modes for Specific Scenes



➔ See *Functions Available in Each Shooting Mode* (p. 222).

Shooting Mode



When a shooting mode appropriate for the shooting conditions is selected, the camera automatically adjusts settings for optimal shooting.

1 Set the mode dial to , , or .

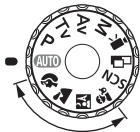

Portrait

Produces a soft effect when photographing people.



Landscape

Optimized for shooting landscape scenes which contain both near and far subjects.



Night Snapshot

Allows you to take snapshots of people against twilight or night backgrounds by reducing the effects of camera shake even without using a tripod.



Kids&Pets

Allows you to capture subjects that move around, such as children and pets, without missing photo opportunities.

SCN (Special Scene)

You can shoot with the most appropriate settings for the scene.

1 Set the mode dial to SCN.

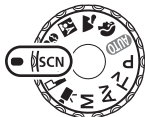

2 Select a shooting mode.

1. Use the control dial to select a shooting mode.

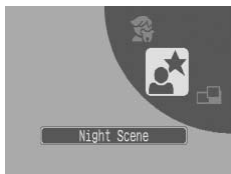

Night Scene

Allows you to capture people against the backdrop of an evening sky or night scene. The flash is directed at the person and the shutter speed is slow, so both the person and the background can be beautifully shot.



Indoor

Prevents camera shake and maintains the subject's true color when shooting under fluorescent or tungsten lighting.

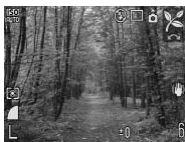

Foliage

Shoots trees and leaves—such as new growth, autumn leaves or blossoms—in vivid colors.



Snow

Shoots without a blue tinge and without making people appear dark against a snowy background.



Beach

Shoots without making people appear dark near water or sand where reflected sunlight is strong.

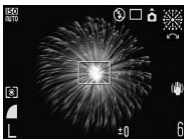

Fireworks







Captures fireworks in the sky sharply and at optimal exposure.



Aquarium

Selects the optimal ISO speed, white balance and color balance to capture fish and other items in an indoor aquarium.



- The shutter speed is slow in  or  mode. Always use a tripod to avoid camera shake.
- In , ,  or  mode, the ISO speed may increase and cause noise in the image depending on the scene being shot.

Movie Shooting



 See *Functions Available in Each Shooting Mode* (p. 222).

Shooting Mode



The following movie modes are available.

The recording time will vary according to the capacity of the memory card you use (p. 200).

Standard

You can select the recording pixels and record until the memory card is full (when a super high-speed memory card is used, such as the recommended SDC-512MSH). The digital zoom can be used while shooting in this mode. (p. 60)

- Maximum Size: 4 GB*

Compact

Since there are few recording pixels and also the data size is small, this mode is convenient for sending movies as e-mail attachments or when the memory card capacity is low.

- Maximum Clip Length: 3 minutes

* Even if the clip size has not reached 4 GB, recording will stop at the moment the clip length reaches 1 hour. Depending on the volume and data writing speed of the memory card, recording may stop before reaching 1 hour or before the recorded data volume has reached 4 GB.

1 Set the mode dial to .



2 Select a shooting mode.

1. Use the control dial to select a movie mode.



3 Shoot.

- Pressing the shutter button halfway automatically sets the exposure, focus and white balance settings.
- Pressing the shutter button fully starts recording video and sound simultaneously.
- During shooting, the recording time and [●Rec] appear on the LCD monitor.
- Pressing the shutter button fully again stops recording. Recording will stop automatically under the following circumstances.
 - When the maximum recording time or maximum size elapses
 - When the built-in memory or memory card becomes full



- You are recommended to use a memory card that has been formatted in your camera to shoot movies (p. 59). The memory card supplied with the camera may be used without further formatting.
- Be careful of the following while recording.
 - Do not touch the microphone (p. 38).
 - If you press a button, the sound of the button being pressed will also be recorded.
 - The camera will automatically adjust the exposure and white balance to suit the shooting conditions during recording. Please note, however, that the sounds made by the camera automatically adjusting the exposure may also be recorded.
- The focus and optical zoom settings remain fixed for subsequent frames at the values selected for the first frame.



- You can set the AE lock and exposure shift while shooting movies. This is effective on ski slopes and the beach when the contrast is too strong between the subject and background or where there are both light and dark areas in the scene and it is desirable to adjust the exposure.
 - 1 Press the **[ISO]** button.







The exposure will lock (AE lock) and the exposure shift bar will appear in the LCD monitor.
 - 2 Use the control dial to adjust the exposure.

Press the **[ISO]** button again to release the setting. Also, the setting will be canceled if you press the **[MENU]** button or change the white balance, My Colors, or shooting mode settings.
- QuickTime is required to play back movies (Data type: AVI/ Compression method: Motion JPEG) on a computer (Only Windows 2000).

Changing Movie Recording Pixels

You can change the recording pixels when the movie mode is set to  (Standard) (frame rate is fixed).





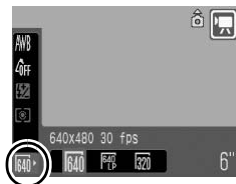

1 Select the number of recording pixels.

1. Press the  button.
2. Use the  or  button to select  and the  or  button to change the option.
3. Press the  button.



Recording Pixels and Frame Rates

Frame rates indicate the number of frames recorded or played back each second. The higher the frame rate, the smoother the appearance of motion.

 Standard	 *1	640 × 480 pixels, 30 frames/sec.
	 *2	640 × 480 pixels, 30 frames/sec. LP
		320 × 240 pixels, 30 frames/sec.
 Compact		160 × 120 pixels, 15 frames/sec.

*1 Default setting.

*2 To give priority to recording length over quality, select the option displaying  (Long Play). For the same file size, you can record approximately twice the length.



- See *Memory Cards and Estimated Capacities* (p. 199).
- See *Image Data Sizes (Estimated)* (p. 200).

Shooting Panoramic Images (Stitch Assist)

 See *Functions Available in Each Shooting Mode* (p. 222).

Shooting Mode

Stitch Assist can be used to shoot overlapping images that can later be merged (stitched) to create one panoramic image on a computer.



The overlapping seams of several adjacent images can be joined into a single panoramic image.



1 Set the mode dial to .



2 Select a shooting direction.

1. Use the control dial to select a shooting sequence.

- Left to right horizontally
- ← Right to left horizontally



3 Shoot the first image in the sequence.

- The exposure and white balance are set and locked with the first image.

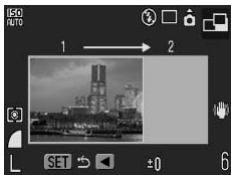

4 Compose the second image so that it overlaps a portion of the first and shoot.

- You can press the ◀ or ▶ button to return to the previously recorded image to retake the shot.
- Minor discrepancies in the overlapping portions can be corrected when the images are stitched together.

5 Repeat the procedure for additional images.

- A sequence may contain up to 26 images.

6 Press the button after taking the last shot.



- You cannot display the images on a TV when shooting in Stitch Assist mode.
- The settings for the first image are applied to the second image onward.



- Use PhotoStitch, a supplied software program, to merge the images on a computer.
- When the  button is pressed, you can switch between the items which you can set.
 - Exposure compensation/Shooting direction selection

P Program AE



See *Functions Available in Each Shooting Mode* (p. 222).

Shooting Mode

AUTO



SCN



P

Tv

Av

M

The camera automatically sets the shutter speed and aperture value to match the brightness of the subject. You can freely configure such settings as the ISO speed, exposure compensation and white balance.

1 Set the mode dial to P.



2 Shoot.



When a correct exposure cannot be obtained, the shutter speed and aperture values are shown in red on the LCD monitor when the shutter button is pressed halfway. Use the following shooting methods to obtain the correct exposure and make them show in white.

- Using the flash (p. 65)
- Changing the ISO speed (p. 110)
- Changing the metering method (p. 115)

Tv Setting the Shutter Speed



➔ See *Functions Available in Each Shooting Mode* (p. 222).

Shooting Mode



When you set the shutter speed, the camera automatically selects an aperture value to match the brightness of the subject. Faster shutter speeds allow you to catch an instantaneous image of a moving subject, while slower speeds create a flowing effect and allow you to shoot without a flash in dark areas.

1 Set the mode dial to Tv.



2 Configure the shutter speed.

1. Use the control dial to change the shutter speed.

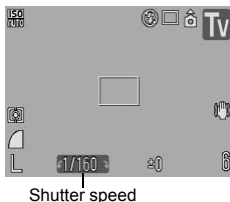

3 Shoot.

- If the aperture value is shown in red, the image is underexposed (insufficient light) or overexposed (too much light). Use the control dial to adjust the shutter speed until the aperture value shows in white (Safety Shift (p. 89)).



The nature of CCDs is such that noise in the recorded image increases at slow shutter speeds. This camera, however, applies special processing to images shot at shutter speeds slower than 1.3 seconds to eliminate the noise, thereby producing high-quality images. (However, a certain amount of processing time may be required before the next image can be shot.)



- The aperture value and shutter speed change according to the zoom state as follows:

	Aperture Value	Shutter Speed (seconds)
Maximum Wide Angle	f/2.8 – 3.5	15 – 1/1600
	f/4.0 – 5.0	15 – 1/2000
	f/5.6 – 8.0*	15 – 1/2500
Maximum Telephoto	f/4.3 – 5.6	15 – 1/1600
	f/6.3 – 8.0*	15 – 1/2000

* Depending on the shooting conditions, the aperture value can increase to f/11 in **AUTO**.

- The fastest shutter speed for flash synchronization is 1/500 second. Therefore, even if the shutter speed is preset to a speed higher than 1/500 second, the camera automatically resets the shutter speed to 1/500 second during shooting.

Shutter Speed Display

- The following shutter speeds can be set. 1/160 indicates 1/160 second. Also, 0"3 indicates 0.3 second and 2" indicates 2 seconds.

15" 13" 10" 8" 6" 5" 4" 3"2 2"5 2" 1"6 1"3 1" 0"8 0"6 0"5 0"4 0"3
 1/4 1/5 1/6 1/8 1/10 1/13 1/15 1/20 1/25 1/30 1/40 1/50 1/60
 1/80 1/100 1/125 1/160 1/200 1/250 1/320 1/400 1/500 1/640
 1/800 1/1000 1/1250 1/1600 1/2000 1/2500

Av Setting the Aperture



➔ See *Functions Available in Each Shooting Mode* (p. 222).

Shooting Mode



The aperture adjusts the amount of light entering through the lens. When you set the aperture value, the camera automatically selects a shutter speed to match the brightness.

Selecting a lower aperture value (opening the aperture) allows you to blur the background and create a beautiful portrait. A higher aperture value (closing the aperture) brings the entire range from foreground to background into focus. The larger the aperture value, the greater the range of the image brought into clear focus.

1 Set the mode dial to Av.



2 Configure the aperture setting.

1. Use the control dial to change the aperture value.



Aperture value

3 Shoot.

- If the shutter speed is shown in red, the image is underexposed (insufficient light) or overexposed (too much light). Use the control dial to adjust the aperture value until the shutter speed shows in white (Safety Shift (p. 89)).



Some aperture values may not be available with certain zoom positions (p. 90).



- The maximum shutter speed with synchronized flash is 1/500 seconds. Therefore, even if an aperture value is preset, the aperture value may automatically be reset to match the synchronized flash speed.

Aperture Value Display

- The larger the aperture value, the smaller the lens aperture.

F2.8 F3.2 F3.5 F4.0 F4.3 F4.5 F5.0 F5.6 F6.3 F7.1 F8.0

Safety Shift

With **Tv** and **Av** modes, if [Safety Shift] is turned [On] (p. 47) in the  menu, the shutter speed or aperture value is automatically adjusted for the correct exposure when it cannot be otherwise obtained. Safety Shift is disabled when the flash is enabled.

M Manually Setting the Shutter Speed and Aperture



➔ See *Functions Available in Each Shooting Mode* (p. 222).

Shooting Mode



You can manually set the shutter speed and aperture to shoot images.

1 Set the mode dial to M.



2 Configure the shutter speed and aperture setting.

1. Use the button to select shutter speed or aperture.
2. Use the control dial to change the shutter speed or aperture value.

3 Shoot.

- When you press the shutter button halfway, the difference between the Correct exposure* and the selected exposure appears on the LCD monitor. If the difference is more than ± 2 stops, “-2” or “+2” appears in red.



* Correct exposure levels are calculated by measuring light according to the currently selected metering mode.



- If the zoom is adjusted after these values are set, the shutter speed or aperture value may change in accordance with the zoom position (p. 88).
- The LCD monitor's brightness matches the selected shutter speed and aperture value. When you select a fast shutter speed or shoot a subject in a dark place, the image will always be bright if the flash is set to (Flash on).

Various Shooting Methods

Continuous Shooting



➔ See *Functions Available in Each Shooting Mode* (p. 222).

Shooting Mode

AUTO

In this mode, the camera shoots continuously while the shutter button is held down. If you use the recommended memory card*, you can shoot continuously (smooth continuous shooting) at a set shooting interval until the memory card is full (p. 199).

*Recommended Memory Card:





Super high-speed SDC-512MSH Memory Card (sold separately) to which low-level formatting (p. 59) is conducted immediately before shooting.

- (Large/Fine) mode.
- This reflects standard shooting criteria established by Canon. Actual results may vary according to the subject and shooting conditions.
- Even if continuous shooting suddenly stops, the memory card may not be full.

			Focus while shooting	Display on the LCD monitor
	Continuous Approx. 1.3 images/sec.	You can shoot continuously at a short shooting interval.	Fixed*	Recorded image
	Continuous Shooting AF Approx. 0.8 images/sec.	The camera will continue to record successive images and focus while the shutter button is held down (except in manual focus mode).	Auto focus	Subject right before shooting
	Continuous Shooting LV (Live View) Approx. 0.8 images/sec.	You can shoot continuously with a manually set focus position while confirming the subject.	Fixed*	Subject right before shooting

* The focus position of first image is fixed.

1 Press the  button.

1. Use the  or  button to select ,  or .







**2 Shoot.**

- The camera will continue to record successive images while the shutter button is held down. Recording will cease when the shutter button is released.

To Cancel Continuous Shooting:

Follow procedure 1 to display .



-  is not displayed in  mode ( can be selected).
- AF frame will be set to [Center] in  mode (p. 98).
- Rec. Review (p. 16) will not be displayed in  and  modes.



- The interval between shots lengthens when the built-in memory of the camera fills.
- If the flash is used, the interval between shots lengthens because the flash must charge.

Setting the Red-Eye Reduction Function

 See *Functions Available in Each Shooting Mode* (p. 222).

Shooting Mode

AUTO     **SCN***   **P Tv Av M**

* Cannot be set in  mode.

This function reduces the red appearance of the eyes which results when the eyes reflect light back from the flash.

1 Select [Red-Eye].

1. Press the  button.
2. In the  menu, use the  or  button to select [Red-Eye].



2 Accept the setting.

1. Use the  or  button to select [On] or [Off].
2. Press the  button.

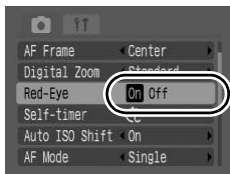

When [On] is selected, the Red-Eye Reduction Lamp lights orange before the flash fires.

Setting the Slow Synchro Function

 See *Functions Available in Each Shooting Mode* (p. 222).

Shooting Mode

        **P** **Tv** **Av** **M**

You can shoot with the flash at slow shutter speeds. When shooting at night or under artificial indoor lighting, this function reduces the effect of background darkening when the flash fires.

1 Select [Slow Synchro].



1. Press the  button.
2. In the  menu, use the  or  button to select [Slow Synchro].



2 Set Slow Synchro.

1. Use the  or  button to select [On] or [Off].
2. Press the  button.



- This will be fixed to [On] in the  and  modes, and , **Tv** and **Av** modes in the **SCN** mode.
- Please note that camera shake becomes a factor when [Slow Synchro] is set to [On]. If this occurs, you are recommended to fix the camera to a tripod to shoot in this mode.

Checking the Focus and Peoples' Expressions (Focus Check)



➔ See *Functions Available in Each Shooting Mode* (p. 222).

Shooting Mode



Allows you to check the focus of an image taken. It is also easy to check peoples' expressions and look for closed eyes because a frame the size of the face displays when AF frame mode is set to [Face Detect] to shoot.

You are recommended to set [Review] to [Hold] in the menu (p. 47) in advance.

1 Select [Review Info].

1. Press the button.
2. In the menu, use the or button to select [Review Info].

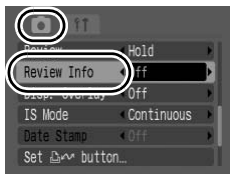

2 Accept the setting.

1. Use the or button to select [Focus Check].
2. Press the button.



3 Shoot.

- The recorded image will be displayed.
- Frames are displayed as follows.

Frame color	Content
Orange	Displays the area of the image shown at the bottom right.
White	Displays at the focal point (AF frame).

- The orange frame can be shown at a different magnification, moved or switched to a different frame (pp. 136, 137).

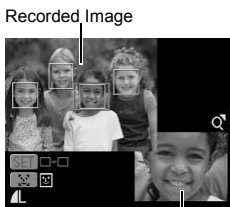



Orange frame contents

To Cancel the Focus Check:

Press the shutter button halfway.



- When [Review Info] is set to any setting other than [Focus Check], the Focus Check screen will display by pressing the  button in the Rec. Review mode immediately after shooting.
- Pressing the  button while the image is displayed will erase the image (p. 21).
- You can check the focus even during playback mode (p. 135).

Switching between Focus Settings

 See *Functions Available in Each Shooting Mode* (p. 222).

Shooting Mode





    *    

* In  mode only [Single] is available.

You can set the AF mode.



Single	The camera only focuses when the shutter button is pressed halfway, conserving battery power.
Continuous	The camera is continually focusing on whatever it is aimed at even when the shutter button is not pressed, allowing you to shoot without missing opportunities.

1 Select [AF Mode].

1. Press the  button.
2. Use the  or  button to select [AF Mode] in the  menu.



2 Accept the setting.

1. Use the  or  button to select [Continuous] or [Single].
2. Press the  button.

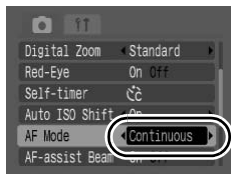

Selecting an AF Frame Mode



➔ See *Functions Available in Each Shooting Mode* (p. 222).

Shooting Mode

AUTO **SCN*** **P Tv Av M**

* Cannot be set in mode.

The AF frame indicates the area of the composition on which the camera focuses. You can set the AF frame in the following ways.

	<p>Face Detect</p>	<p>You can have the camera automatically detect the position of a face and use this data to set the focus and exposure* while shooting. In addition, the camera will meter the subject so that the face is correctly illuminated when the flash fires. If a face is not detected, shooting will take place with [Center]. * Only in evaluative metering mode (p. 115).</p>
	<p>Center</p>	<p>The camera fixes the AF frame at the center. This is convenient for making sure the focus is exactly where you want it.</p>

1 Select [AF Frame].

1. Press the button.
2. In the menu, use the or button to select [AF Frame].

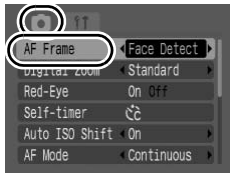

2 Accept the setting.

1. Use the or button to select [Face Detect] or [Center].
2. Press the button.
 - Changing the AF frame size (p. 100).

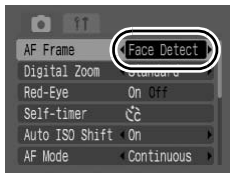



The AF frame appears as follows when the shutter button is pressed halfway.

- Green : In focus
- Yellow : Focusing difficulty ([Center] option)
- No AF frame : Focusing difficulty ([Face Detect] option)

Face Detect Feature

- Maximum of three AF frames will be displayed at the position of the face the camera recognizes. At this point, the frame the camera judges to be the main subject appears in white while the others appear in gray. When the shutter button is pressed halfway and the camera focuses, up to 9 green AF frames may appear.
- The camera will shoot using [AiAF] not the [Face Detect] function if a white frame fails to appear and only gray frames display, or if a face is not detected.
- The camera may mistakenly identify non-human subjects as a face. In this case, select [Center].
- In certain cases, faces may not be detected.
Examples:
 - If faces are at the edge of the screen, or appear extremely small, large, dark or bright, relative to the overall composition.
 - Faces turned to the side or at a diagonal, or faces with a portion hidden.

Changing the AF Frame Size ([Center] selected)

Shooting Mode

 AUTO     SCN   P Tv Av M

You can change the AF frame size to match a subject.



You reduce the area used to set the focus when you reduce the AF frame to match a small subject or to focus on a particular portion of a subject.

1 Select [AF Frame Size].

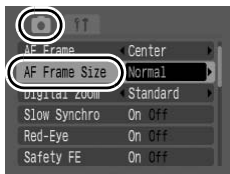
1. Press the  button.
2. In the  menu, use the  or  button to select [AF Frame Size].



2 Accept the setting.

1. Use the  or  button to select [Normal] or [Small].
2. Press the  button.

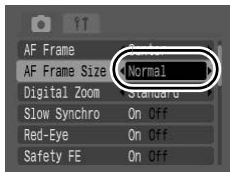

The setting is configured to [Normal] when the digital zoom, digital tele-converter or manual focus mode (p. 105) is used.

Selecting a Subject to Focus On (When [Face Detect] Is Selected)



See *Functions Available in Each Shooting Mode* (p. 222).

Shooting Mode

AUTO



* Cannot be set in mode.

Once the focus is fixed to a subject's face, the frame can be set to follow the subject (Face Select and Track).

1 Select a face you wish to focus on.

1. When a face is detected, press the button.

- The camera enters face designation mode, and the face frame () of the main subject displays in green. Even if the subject moves, the frame will follow the subject within a certain range.

Face Frame

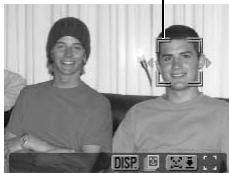

2. Select the person you wish to focus on.

- When several faces have been detected, pressing the or button or turning the control dial will move the face frame to another subject.
- The face frame will not display when a face is not detected. When the AF frame mode is set to [Center], will display in green in the center of the monitor.
- Holding down the **DISP.** button will display face frames (up to 35) of all the detected faces (green: face of main subject, white: detected faces).
- The **MENU** button and button cannot be used.

Face Frame



3. Press the $\left[\begin{smallmatrix} \uparrow \\ \downarrow \end{smallmatrix} \right]$ button again.

- The camera exits face designation mode, and the face frame ($\left(\begin{smallmatrix} \uparrow & \rightarrow \\ \leftarrow & \downarrow \end{smallmatrix} \right)$) of the main subject will change to white. The frame will continue to follow the subject within a certain range.
- You can make shooting function settings in the FUNC. menu.

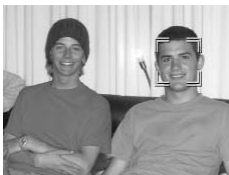
**2 Press the shutter button halfway.**

- The face frame ($\left(\begin{smallmatrix} \uparrow & \rightarrow \\ \leftarrow & \downarrow \end{smallmatrix} \right)$) of main subject will change into \square .

3 Press the shutter button all the way to shoot.**To Cancel the Face Select Mode:**

Press the $\left[\begin{smallmatrix} \uparrow \\ \downarrow \end{smallmatrix} \right]$ button more than one second in Step 1.



- In the following cases, the face select mode will be canceled.
 - When turning the power back on
 - Using the digital zoom or digital tele-converter
 - When the **MENU** button is pressed to display the menu.
 - When a selected face cannot be tracked for several seconds.
- When the AF frame mode is set to [Center], you cannot select faces while using the digital zoom.

Shooting Hard-to-Focus Subjects

(Focus Lock, AF Lock, Manual Focus, Safety MF)

 See *Functions Available in Each Shooting Mode* (p. 222).

Shooting Mode

* Cannot be used in  mode.

It may be difficult to focus on the following types of subjects.



- Subjects with extremely low contrast to the surroundings
- Scenes with a mixture of near and far subjects
- Subjects with extremely bright objects at the center of the composition
- Subjects that are moving quickly
- Subjects through glass: Try to shoot as close to the glass as possible to reduce the chances of light reflecting back off the glass.

Shooting with the Focus Lock





- 1 Aim the camera so that an object at the same focal distance as the main subject is centered in the viewfinder or in the AF frame displayed on the LCD monitor.**
- 2 Press the shutter button halfway to lock the focus.**
- 3 Keep the shutter button pressed halfway while you recompose the image and press the shutter button all the way to shoot the image.**

Shooting with the AF Lock

* Not available in  or  mode.

- 1** Aim the camera so that an object at the same focal distance as the main subject is centered in the AF frame.
- 2** Press and hold the shutter button halfway and press the  button.
 -  and MF Indicator will be displayed to confirm the distance from the subject.
- 3** Re-aim the camera to compose the shot as desired and shoot.

To Release the AF Lock:

Press the  button and use the  or  button to select  (Normal).



- Since AF frames do not display in  mode, aim the camera so that the focus is on the target subject.
- When shooting with the focus lock or AF lock using the LCD monitor, setting [AF Frame] to [Center] (p. 98) makes shooting easier since the camera focuses using the center AF frame only.
- The AF lock is convenient because you can let go of the shutter button to compose the image. Moreover, the AF lock is still effective after the picture is taken, allowing you to capture a second image with the same focus.

Shooting in Manual Focus Mode

The focus can be manually set.

* Not available in **AUTO** or  mode.

1 Press the **MF** button.







1. Use the  or  button to select **MF**.

- The **MF** and the MF indicator are displayed.
- When the  menu's [MF-Point Zoom] is set to [On], the portion of the image in the AF frame will appear magnified*.

* The image will not appear magnified in  mode, when the digital zoom or digital tele-converter is activated or when a TV is used as the display.

* Can also be set so that the image displayed is not magnified (p. 47).

- Depending on the shooting mode, pressing the  button will switch between the setting items as follows:

 ,  ,  ,  , P	Exposure compensation/ MF
SCN	SCN mode/Exposure compensation/ MF
	 mode/ MF
Tv	Shutter speed/Exposure compensation/ MF
Av	Aperture value/Exposure compensation/ MF
M	Shutter speed/Aperture value/ MF



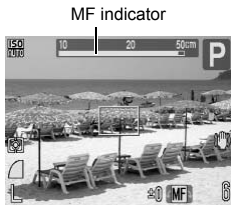

2 Use the control dial and adjust the focus.

- The MF indicator shows approximate figures. Use them as a shooting guideline only.



To Cancel the Manual Focus:

Press the **MF** button and use the  or  button to select  (Normal).



You cannot change the AF frame setting while focusing manually. Cancel the manual focus mode, then change the AF frame setting.

Using the Manual Focus in Combination with the Auto Focus (Safety MF)

First, manual focus is used to roughly focus, then from that focus position the camera automatically focuses more accurately.

* Not available in **AUTO** or mode.

1 Select [Safety MF].

1. Press the button.
2. In the menu, use the or button to select [Safety MF].



2 Accept the setting.

1. Use the or button to select [On] or [Off].
2. Press the button.



3 First focus manually and then press the shutter button halfway.

- The focus will be fine-tuned at the optimal point of focus.

4 To shoot, press the shutter button all the way down (press fully).

Locking the Exposure Setting (AE Lock)

 See *Functions Available in Each Shooting Mode* (p. 222).

Shooting Mode



You can set the exposure and focus separately. This is effective when the contrast is too strong between the subject and background or when a subject is backlit.

1 Confirm that the flash is lowered.

-  is displayed.



2 Aim the camera at the subject on which you wish to lock the exposure.

3 Press the shutter button halfway and press the button.

- The exposure setting will lock and  will display.

4 Re-aim the camera to compose the shot as desired and press the shutter button fully.

To Release the AE Lock:

Operate a button other than the  or  button.



- You can also set or release the AE lock (p. 81).
- You can use the FE lock when using the flash (p. 109).

Changing the Shutter Speed and Aperture Value Combination

The automatically selected combinations of shutter speeds and aperture values can be freely changed without altering the exposure to shoot images (Program Shift).

1 Aim the camera at the subject on which you wish to lock the exposure.

2 Press the shutter button halfway and press the  button.

- The exposure setting will lock, and  will appear on the LCD monitor.



3 Use the control dial to change shutter speed and aperture value combinations.

4 Recompose the image and shoot.

- The setting will cancel after the shot is taken.

Locking the Flash Exposure Setting (FE Lock)





 See *Functions Available in Each Shooting Mode* (p. 222).

Shooting Mode

AUTO



You can lock the flash exposure so that the exposure settings are correctly set regardless of the composition of your subject.

- 1 Raise the flash.**
- 2 In P mode, press the  button and select  (flash on).**
- 3 Aim the camera at the subject on which you wish to lock the exposure.**
- 4 Press the shutter button halfway and press the  button.**
 - The flash will pre-fire and  will display.
- 5 Re-aim the camera to compose the shot as desired and press the shutter button fully.**

To Release the FE Lock:

Operate a button other than the control dial.



The FE lock cannot be used when [Flash Adjust] is set to [Off].

ISO Adjusting the ISO Speed



➔ See *Functions Available in Each Shooting Mode* (p. 222).

Shooting Mode

AUTO



P Tv Av M

Raise the ISO speed to use a fast shutter speed when you wish to reduce the effects of camera shake or avoid blurry subjects, or to turn the flash off when shooting in a dark area.

Shooting Mode \ ISO Speed	AUTO	P	Tv	Av	M
Auto	○*	○*	○*	○*	–
High ISO Auto	○	○	–	–	–
ISO 80	–	○	○	○	○*
ISO 100	–	○	○	○	○
ISO 200	–	○	○	○	○
ISO 400	–	○	○	○	○
ISO 800	–	○	○	○	○
ISO 1600	–	○	○	○	○

○:Available *:Default

1 Adjust the ISO Speed.

1. Press the **ISO** button.
2. Use the **←** or **→** buttons to change the setting.



- Selecting **ISO AUTO** (Auto) puts priority on image quality in setting the optimal ISO speed for the light level when shooting. As the ISO speed will automatically be raised in dark places, shutter speed will increase, reducing camera shake and subject blurring.
- Selecting **ISO HI** (High ISO Auto)* sets a higher speed than for **ISO AUTO**. As the shutter speed becomes even faster, camera shake and blurred photos caused by subject movement will be reduced even more than when shooting the same scene in **ISO AUTO**.

* Noise may increase in the captured image compared to **ISO AUTO**.



- The camera automatically applies noise reduction processing when you shoot at a high ISO speed.
- If the camera is set at **ISO AUTO** or **ISO HI**, the ISO speed automatically set by the camera will be displayed when pressing the shutter button halfway or in playback information.

Reducing Camera Shake When Shooting (Auto ISO Shift)

 See *Functions Available in Each Shooting Mode* (p. 222).

Shooting Mode

AUTO



SCN



P Tv

Av

M

When the camera shake warning icon () appears during shooting, this function allows you to increase ISO speed and to shoot at a shutter speed which minimizes the effects of camera shake.

Off	This function is not used.
 button	Allows you to confirm the ISO speed and shutter speed before and after adjustment in the LCD monitor while shooting.
On	The ISO speed is automatically adjusted to an optimal setting which minimizes camera shake.



- In **ISO HI**, **ISO 800** or **ISO 1600** mode, it will not function when the flash fires.
- Depending on shooting conditions, the camera shake warning icon () may continue to display even if the ISO speed is increased.

1 Select [Auto ISO Shift].

1. Press the **MENU** button.
2. In the  menu, use the **↑** or **↓** button to select [Auto ISO Shift].



2 Accept the setting.

1. Use the ← or → button to select [] button], [On] or [Off].
2. Press the button.

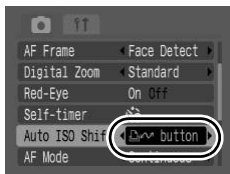

■ Shooting ([] button) is Selected)

3 Press the shutter button halfway.

- When is displayed, the [] button lights in blue.



4 Press and hold the shutter button halfway, then press the button.

- The ISO speed after adjustment is displayed.
- While pressing the shutter button halfway, pressing the [] button again will return the ISO speed to its original condition.
- When the AE lock (p. 107) is activated after the ISO speed is raised, the ISO speed will not return to its original setting even if you release the shutter button.



5 Press the shutter button all the way down (press fully).

■ Shooting ([On] is Selected)

3 Press the shutter button halfway.

- The ISO speed is automatically set to an optimal setting which minimizes camera shake.



4 Press the shutter button all the way down (press fully).

Adjusting the Exposure Compensation

 See *Functions Available in Each Shooting Mode* (p. 222).

Shooting Mode

        **P** Tv Av M

Adjust the exposure compensation to a positive value to avoid making the subject too dark when it is backlit or shot against a bright background. Adjust the exposure compensation to a negative value to avoid making the subject too bright in night shots or when shot against a dark background.

1 Press to display the exposure compensation bar.

2 Configure the setting.

1. Use the control dial to adjust the exposure compensation.
2. Press the  button.



- Depending on the shooting mode, pressing the  button will switch between the setting items as follows:

SCN	SCN mode/Exposure compensation
	Sequence Direction Selection/Exposure compensation
Tv	Shutter speed/Exposure compensation
Av	Aperture value/Exposure compensation

To Cancel the Exposure Compensation:



Follow step 2 to restore the compensation value to [0].

Switching between Metering Modes







 See *Functions Available in Each Shooting Mode* (p. 222).

Shooting Mode

	Evaluative	Appropriate for standard shooting conditions, including backlit scenes. The camera divides images into several zones for metering. It evaluates complex lighting conditions, such as the position of the subject, the brightness, the direct light, and the backlighting, and adjusts the settings to the correct exposure for the main subject.
	Center Weighted Avg.	Averages the light metered from the entire frame, but gives greater weight to the subject matter at the center.
	Spot	Meters within the spot metering frame.

1 Change the metering mode.

1. Press the  button.
2. Use the  or  button to select  and the  or  button to change the option.
3. Press the  button.









Adjusting the Tone (White Balance)

 See *Functions Available in Each Shooting Mode* (p. 222).







Shooting Mode

        **P**   



Normally, the **AWB** (Auto) white balance setting selects an optimal white balance. When the **AWB** setting cannot produce natural looking colors, change the white balance using a setting appropriate for the light source.

	Auto	Settings are automatically set by the camera.
	Day Light	For recording outdoors on a bright day.
	Cloudy	For recording under overcast, shady or twilight skies.
	Tungsten	For recording under tungsten and bulb-type 3-wavelength fluorescent lighting.
	Fluorescent	For recording under warm-white, cool-white or warm-white (3-wavelength) fluorescent lighting.
	Fluorescent H	For recording under daylight fluorescent, or daylight fluorescent-type 3-wavelength fluorescent lighting.
	Custom	For recording with the optimal white balance data memorized in the camera from a white-colored object, such as white paper or cloth.

1 Select a white balance setting.

1. Press the  button.
2. Use the  or  button to select **AWB** and the  or  button to change the option.
3. Press the  button.









The white balance setting cannot be adjusted when  or  is selected for My Colors.

Using the Custom White Balance

Take a custom white balance  (Custom) reading for the following situations that are difficult for the  (Auto) setting to detect correctly.

- Shooting close-ups (Macro)
- Shooting subjects of monotone color (such as sky, sea or forest)
- Shooting with a particular source of light (such as a mercury-vapor lamp)

1 Select .

1. Press the  button.
2. Use the  or  button to select  and choose  with the  or  button.





2 Aim the camera at a piece of white paper or cloth and press .

- If you are viewing it with the LCD monitor, ensure that the center frame is completely filled with the white image. If you are using the optical viewfinder, ensure that the entire field is filled. Please note, however, that the center frame will not display when the digital zoom is used or when  is displayed.



3 Press the button.



- You are recommended to set the shooting mode to **P** and the exposure compensation setting to $[\pm 0]$ before setting a custom white balance. The correct white balance may not be obtained when the exposure setting is incorrect (image appears completely black or white).
- Shoot with the same settings as when reading the white balance data. If the settings differ, the optimal white balance may not be set. In particular, the following should not be changed.
 - ISO Speed
 - Flash
 - Setting the flash to  or  is recommended. If the flash fires when reading the white balance data with the flash set to , make sure that you also use the flash when you shoot.
- Since the white balance data cannot be read in Stitch Assist mode, preset the white balance in another shooting mode beforehand.
- The white balance data is retained even after the camera power is turned off.

Shooting in a My Colors Mode



➔ See *Functions Available in Each Shooting Mode* (p. 222).

Shooting Mode

AUTO SCN P Tv Av M

You can change the look of an image when it is shot.

	My Colors Off	Records normally with this setting.
	Vivid	Emphasizes the contrast and color saturation to record bold colors.
	Neutral	Tones down the contrast and color saturation to record neutral hues.
	Sepia	Records in sepia tones.
	B/W	Records in black and white.
	Custom Color	Use this option to adjust contrast, sharpness and saturation before shooting.

1 Select a My Colors setting.

1. Press the button.
2. Use the or button to select and the or button to change the option.
3. Press the button.



2 Shoot.

AC (Setting the Custom Color Mode)

1 Select **AC**.

1. Press the **FUNC. SET** button.
2. Use the **▲** or **▼** button to select **COFF** and choose **AC** with the **◀** or **▶** button.



2 Adjust the setting.

1. Press the **DISP.** button.
2. Use the **▲** or **▼** button to select [Contrast], [Sharpness] or [Saturation].
3. Use the **◀** or **▶** button to adjust the setting.



Select an item

Adjust

- The adjustment results show in the LCD monitor.
- If you press the **DISP.** button, you will return to the screen where you can select a My Colors mode.

3 Complete the setting.

1. Press the **FUNC. SET** button.

Switching between Flash Adjustment Settings



➔ See *Functions Available in Each Shooting Mode* (p. 222).

Shooting Mode

AUTO



Although the built-in flash will fire with automatic flash adjustments, it is also possible to set it so that it fires without any adjustments.

1 Select [Flash Adjust].

1. Press the **MENU** button.
2. In the menu, use the **↑** or **↓** button to select [Flash Adjust].



2 Accept the setting.

1. Use the **←** or **→** button to select [Auto] or [Manual].
 - Flash compensation can be set to [Auto] (p. 122).
 - Flash output can be set to [Manual] (p. 123).
2. Press the **MENU** button.



Adjusting Flash Compensation Settings







 See *Functions Available in Each Shooting Mode* (p. 222).

Shooting Mode

        **P Tv Av M**

Flash exposure compensation can be adjusted in the range of -2 to $+2$ stops in $1/3$ -stop increments. You can combine the flash exposure compensation with the camera's exposure compensation function for balanced exposure of the background when doing flash photography. In **Tv** and **Av** shooting modes, please set [Flash Adjust] to [Auto].

1 Adjust the flash compensation setting.

1. Press the  button.
2. Use the  or  button to select  and the  or  button to change the option.
3. Press the  button.



Flash exposure compensation

Setting the Flash Output



➔ See *Functions Available in Each Shooting Mode* (p. 222).

Shooting Mode

AUTO



SCN



P

Tv







Av

M

When shooting, the flash output can be controlled in three steps, up to FULL.

In **Tv** and **Av** shooting modes, please set [Flash Adjust] to [Manual].

1 Configure the flash output setting.

1. Press the  button.
2. Use the  or  button to select  and the  or  button to change the option.
3. Press the  button.

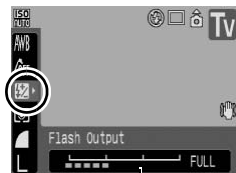

Flash Output

Adjusting Exposure for Built-in Flash Shooting (Safety FE)

 See *Functions Available in Each Shooting Mode* (p. 222).

Shooting Mode

        **P Tv Av M**

The camera automatically changes the shutter speed or aperture value when the flash fires to avoid overexposing and blowing out the highlights in the scene. In **Tv** or **Av** shooting mode, Ensure that the flash adjustment setting is configured to [Auto] in advance (p. 121).

1 Select [Safety FE].

1. Press the  button.
2. In the  menu, use the  or  button to select [Safety FE].



2 Accept the setting.

1. Use the  or  button to select [On] or [Off].
2. Press the  button.



Registering Settings to the Print/Share Button

 See *Functions Available in Each Shooting Mode* (p. 222).

Shooting Mode















P Tv Av M

You can register a function that you often use when shooting with the  (Print/Share) button. The following functions can be registered.





Menu Item	Page	Menu Item	Page
 Not Assigned	—	 Digital Tele-converter	p. 64
 White Balance	p. 116	 DISP. Overlay	p. 127
 Custom White Balance	p. 117	 Display Off	p. 126

1 Select [Set button].

1. Press the  button.
2. In the  menu, use the  or  button to select [Set  button].
3. Press the  button.



2 Accept the setting.

1. Use the  or  button to select the function you wish to register.
2. Press the  button.
 - If  displays to the icon's lower right, you can register the function, but you cannot use it with some shooting modes or settings even if you press the  button.

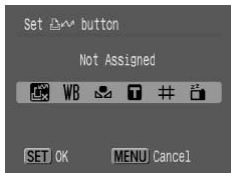











3 Press the button.

To Cancel the Shortcut Button:

Select  in Step 2.

Using the Button

1 Press the button.

- For  and , each time that the  button is pressed, the settings of the registered functions are switched.
- For , the corresponding setup screen is displayed.
- For , each press of the  button records the white balance data. Since the frame does not appear at this point, ensure that the white paper or cloth is positioned so it appears at the center of the LCD monitor and then press the  button. After using this function once, the white balance setting changes to .
- For , pressing the  button turns off the LCD monitor. The next time a button is pressed, the LCD monitor will turn back on.

Setting the Display Overlays



➔ See *Functions Available in Each Shooting Mode* (p. 222).

Shooting Mode



* Only [Grid Lines] can be set.

You can display vertical and horizontal grid lines, a 3:2 print area guide, or both on the LCD monitor while shooting to help check the position of your subject.

Off	—
Grid Lines	Displays grid lines to divide the screen into 9 parts. Helps confirm the vertical and horizontal positioning of the subject.
3:2 Guide	Helps confirm the print area for a 3:2 print.* Areas outside the printable area are grayed out. * Images are still recorded at the standard aspect ratio of 4:3.
Both	Displays both the grid lines and the 3:2 guide simultaneously.

1 Select [Disp. Overlay].

1. Press the button.
2. In the menu, use the or button to select [Disp. Overlay].

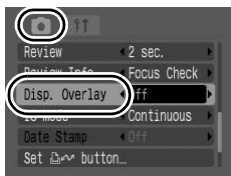

2 Accept the setting.

1. Use the or button to select [Off], [Grid Lines], [Both] or [3:2 Guide].
2. Press the button.

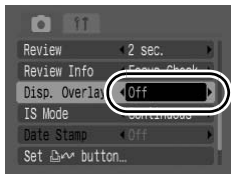

- Only grid lines can be configured for the or mode.
- The grid lines and 3:2 guide will not be recorded in the image.

Setting the Auto Rotate Function



➔ See *Functions Available in Each Shooting Mode* (p. 222).

Shooting Mode



Your camera is equipped with an Intelligent Orientation sensor that detects the orientation of an image shot with the camera held vertically and automatically rotates it to the correct orientation when viewing it in the LCD monitor.

1 Select [Auto Rotate].

1. Press the **MENU** button.
2. Use the **◀** or **▶** button to select the **ff** menu.
3. Use the **▲** or **▼** button to select [Auto Rotate].



2 Accept the setting.

1. Use the **◀** or **▶** button to select [On] or [Off].
2. Press the **MENU** button.
 - When the Auto Rotate function is set to [On] and the LCD monitor is set to the detailed display mode in the shooting mode, **⏏** (normal), **⏏** (right end is down) or **⏏** (left end is down) will appear in the display.

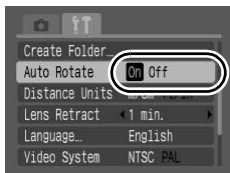

- This function may not operate correctly when the camera is pointed straight up or down. Check that the arrow **⏏** is pointing in the right direction and if it is not, then set the Auto Rotate function to [Off].
- Even if the Auto Rotate function is set to [On], the orientation of images downloaded to a computer will depend upon the software used to download the images.



When the camera is held vertically to shoot, the Intelligent Orientation sensor judges the upper end to be “up” and the lower end to be “down”. It then regulates the optimal white balance, exposure and focus for vertical photography. This function operates regardless of the on/off status of the Auto Rotate function.

Creating an Image Destination (Folder)



➔ See *Functions Available in Each Shooting Mode* (p. 222).

Shooting Mode



You can create a new folder at any time and the recorded images will be automatically saved to that folder.

Create New Folder	Creates a new folder the next time you shoot images. To create an additional folder, insert the check mark again.
Auto Create	You can also specify a date and time if you wish to create a new folder using a shooting time after the specified date and time.



Creating a Folder the Next Time You Shoot.

1 Select [Create Folder].

1. Press the button.
2. Use the or button to select the menu.
3. Use the or button to select [Create Folder].
4. Press the button.



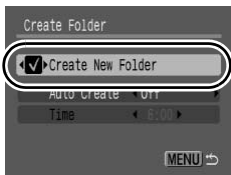

2 Accept the setting.

1. Use the ◀ or ▶ button to check mark [Create New Folder].
2. Press the  button two times.
 -  will be displayed on the LCD monitor when shooting.  will disappear from the screen when a new folder is created.





Setting the Day or Time for Automatic Folder Creation.

1 Select [Create Folder].

1. Press the  button.
2. Use the ◀ or ▶ button to select the  menu.
3. Use the ▲ or ▼ button to select [Create Folder].
4. Press the  button.



2 Accept the setting.

1. Use the ▲ or ▼ button to select [Auto Create] and the ◀ or ▶ button to select a creation date.
2. Use the ▲ or ▼ button to select [Time] and the ◀ or ▶ button to select a time.
3. Press the  button two times.
 -  displays when the specified time arrives. The symbol will cease to display after the new folder is created.

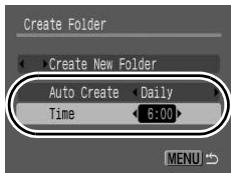

Up to 2000 images can be saved into one folder. A new folder will automatically be created when you record more than that number even if you are not creating new folders.

Resetting the File Number



➔ See *Functions Available in Each Shooting Mode* (p. 222).

Shooting Mode



The images you shoot are automatically assigned file numbers. You can select how the file number is assigned.

<p>Continuous</p>	<p>A number one higher than the last one recorded is assigned to the next image. This is convenient for managing all your images together on a computer because you avoid file name duplication when changing folders or memory cards.*</p> <p>* When a blank memory card is used. If a memory card with recorded data is used, the 7-digit number for the last recorded folder and image is compared with the last one on the memory card, and the larger of the two is utilized as the basis for new images.</p>
<p>Auto Reset</p>	<p>The image and folder number are reset to the starting value (100-0001).* This is convenient for managing images on a folder-by-folder basis.</p> <p>* When a blank memory card is used. If a memory card with recorded data is used, the number following the 7-digit number for the last recorded folder and image on the memory card is utilized as the basis for new images.</p>

1 Select [File Numbering].

1. Press the **MENU** button.
2. Use the **←** or **→** button to select the **ff** menu.
3. Use the **↑** or **↓** button to select [File Numbering].

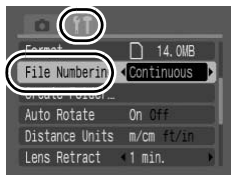

2 Accept the setting.

1. Use the **←** or **→** button to select [Continuous] or [Auto Reset].
2. Press the **MENU** button.

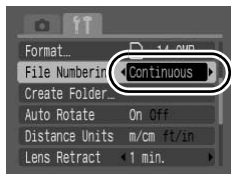

File and Folder Numbers

Recorded images are assigned consecutive file numbers starting with 0001 and ranging up to 9999, while folders are assigned numbers starting with 100 and ranging up to 999. Up to 2000 images can be saved into a single folder.

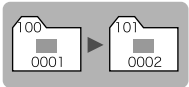
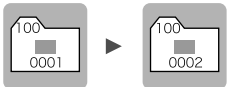
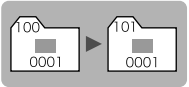
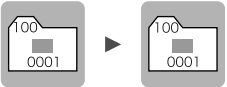
	New Folder Created	Memory Card Exchanged for Another
Continuous	<p>Memory Card 1</p> 	<p>Memory Card 1 Memory Card 2</p> 
Auto Reset	<p>Memory Card 1</p> 	<p>Memory Card 1 Memory Card 2</p> 

- Images may be saved to a new folder when there is insufficient free space even if the total number of images in a folder is less than 2000 because the following types of images are always saved together into the same folder.
 - Images from continuous shooting
 - Self-timer images (custom)
 - Stitch Assist mode images
- Images cannot be played back when the folder numbers are duplicated or image numbers are duplicated within folders.
- Please refer to the *Software Starter Guide* for information regarding folder structures or image types.

Playback/Erasing

In playback mode, you can select images with the control dial. Turning it counterclockwise selects the previous image while turning it clockwise selects the next image. Please also see Viewing Still Images (p. 17).

Q Magnifying Images



1 Press the zoom lever toward Q.

- The image is magnified.
- Images can be magnified up to a factor of 10x.



Approximate Location
of the Displayed Area

2 Use the ↑, ↓, ← or → button to move around the image.

- If you use the control dial while in the magnified display mode, the camera will switch to the previous or next image at the same level of magnification.
- You can change the magnification level with the zoom lever.

To Cancel the Magnified Display:

Press the zoom lever toward . (You can also cancel it immediately by pressing the **MENU** button.)







Movie frames and index playback images cannot be magnified.

Viewing Images in Sets of Nine (Index Playback)



1 Press the zoom lever toward .

- Up to nine images can be viewed at once in index playback.
- Use the , ,  or  button to change the image selection.

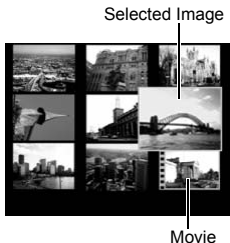





To Return to Single Image Playback:

Press the zoom lever toward .

Switching between Sets of Nine Images

The jump bar will display if you press the zoom lever toward  while in index playback and you can switch the display between sets of nine images.

- Use the  or  button to move to the previous or next set of 9 images.
- Hold the **FUNC./SET** button down and press the  or  button to jump to the first or last set.

To Return to Single Image Playback:

- Press the zoom lever toward .



Check the Focus and Facial Expressions of Subjects (Focus Check Display)

Focus Check display allows you to check the focus of images taken. Moreover, as you can change the display magnification and switch images, you can easily check facial expressions and whether a subject's eyes are closed.

Displaying the Focus Check

- 1** Press the  button several times until the Focus Check displays.



- Frames are displayed on the image as follows.

Frame color	Content
Orange	Displays the range of the image displayed at bottom right.
White	The frame is displayed at a position at which the image is in focus.
Gray	Displays frames in positions where faces were detected during playback.

- The orange frames allow you to change the display magnification, move the display position, and switch between display frames (pp. 136, 137).



When you are not using Focus Check display and playing back images with detected faces, you can change the display magnification by pressing the  button.

Changing the Display Magnification

2 Press the zoom lever toward .

- Screen bottom right will be displayed prominently.



Switching Frames

2 Press the button.

- When multiple faces are detected, pressing the  button switches the position of the orange frame.

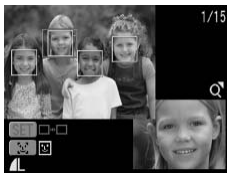



Changing the Display Position

2 Press the zoom lever toward .

- Screen bottom right will be displayed prominently.



3 Use the , , or button to change the display position.

- When multiple faces are detected, each press of the  button switches between the different positions of the orange frames.
- When only one face is detected, pressing the  button will return the orange frame to its original position.
- After you change the display magnification in a shot with detected faces and press the  button, the orange frame will adjust to the size of the face.
- When no faces are detected, pressing the **FUNC./SET** button will return the orange frame to its original position.







To Return to Single Image Playback:

Press the **MENU** button.

Jumping to Images

When you have many images recorded onto a memory card, it is handy to use the five search keys below to jump over images to find the object of your search.

	Jump Shot Date	Jumps to the first image of each shooting date.
	Jump to Folder	Jumps to the first image of each folder.
	Jump to Movie	Jumps to a movie.
	Jump 10 Images	Jumps over 10 images at a time.
	Jump 100 Images	Jumps over 100 images at a time.

1 In single image playback mode, press the button.

- The camera will switch to jump search mode.
- The screen sample will vary slightly according to the search key.

2 Use the **↑** or **↓** button to select a search key and press the **←** or **→** button.

Number of images matching search key



Location of image currently being displayed

To Return to Single Image Playback:



Press the **MENU** button.

Viewing Movies (Movie Replay Control Panel)





Movies cannot be played in the index playback mode.

1 Display the movie file.

1. Use the ◀ or ▶ button to select a movie.
2. Press the  button.
 - Images with a  icon are movies.
 - The Movie Control Panel is displayed.



2 Play the movie.

1. Use the ◀ or ▶ button to select .
2. Press the  button.
 - The movie will pause if you press the **FUNC./SET** button during playback. It will resume when you press the button again.
 - When playback ends, the movie stops at the last frame displayed. Press the **FUNC./SET** button to display the movie control panel.
 - You can switch between showing/hiding the playback progress bar by pressing the **DISP.** button while playing a movie.
 - If playback was halted partway through in the prior viewing session, playback will resume from the last frame displayed.

Movie Control Panel











Playback Progress Bar

Time movie was shot

Volume Level
(Adjust it with the ▲ or ▼ button)

Operating the Movie Control Panel

	Exit	Ends playback and returns to single image playback.
	Print	An icon will display when a printer is connected. See the <i>Direct Print User Guide</i> for details.
	Play	Play
	Slow Motion	You can use the ◀ button to slow down or the ▶ button to speed up playback.
	First Frame	Displays the first frame.
	Previous Frame	Rewinds if the FUNC./SET button is held down.
	Next Frame	Fast Forwards if the FUNC./SET button is held down.
	Last Frame	Displays the last frame.



- Use the television's controls to adjust the volume when playing a movie on a TV set (p. 161).
- The sound cannot be played in slow motion playback.

Rotating Images in the Display



Images can be rotated clockwise 90° or 270° in the display.

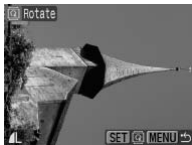

Original

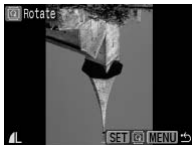

90°



270°

1 Select [Rotate].

1. Press the **MENU** button.
2. In the menu, use the **↑** or **↓** button to select [Rotate].
3. Press the button.

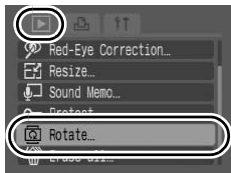

2 Rotate the image.

1. Use the **←** or **→** button to select an image to rotate.
2. Press the button.
 - Cycle through the 90°/270°/original orientations with each press of the **FUNC./SET** button.
 - This also can be set in the index playback mode.

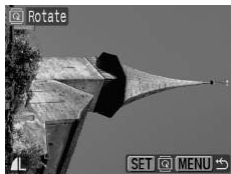

When images are downloaded to a computer, the orientation of images rotated by the camera will depend upon the software used to download the images.



As the orientation of an image is recorded, the image will be shown in its rotated orientation the next time it is displayed.

Playback with Transition Effects



You can select the transition effect displayed when switching between images.

	No transition effect.
	The displayed image darkens and the next image gradually brightens until it is displayed.
	Press the button to have the previous image display from the left and the button to have the next image display from the right.

1 Select [Transition].

1. Press the button.
2. In the menu, use the or button to select [Transition].



2 Accept the setting.

1. Use the or button to select a transition effect.
2. Press the button.

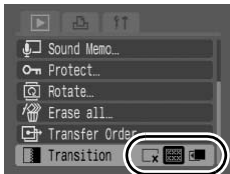



Automated Playback (Auto Play)

Use this feature to automatically play back all of the images in the memory card. The LCD monitor displays each image for approximately 3 seconds.

1 Select [Auto Play].

1. Press the  button.
2. In the  menu, use the  or  button to select [ Auto Play].
3. Press the  button.



- During automated playback, the following functions are possible:
 - Pausing/resuming the Auto Play: Press the **FUNC./SET** button
 - Fast forwarding/rewinding: Press the  or  button (holding down the button will increase the speed of the Fast Forward)
 - Stopping: Press the **MENU** button



If Transition is selected (p. 142), the selected transition effects appear between images.

Red-Eye Correction Function



You can correct red eyes in recorded images.



Red eyes may not be automatically detected in some images or the results may not turn out as you intended.

Examples:

- Faces near the screen edges or faces that appear extremely small, large, dark or bright in relation to the overall image.
- Faces turned to the side or at a diagonal, or faces with a portion hidden.

1 Select [Red-Eye Correction].

1. Press the button.
2. In the menu, use the or button to select [Red-Eye Correction].
3. Press the button.



2 Select an image.

1. Use the or button to select the image you wish to correct red eyes.
2. Press the button.
 - A frame will automatically display where a red-eye is detected.
 - If red-eye is not automatically detected, select [Add Frame] with or button and press **FUNC./SET** button (p. 147).
 - To cancel the correction frame, select [Remove Frame] and press the **FUNC./SET** button (p. 148).



3 Correct the image.

1. Use the **↑**, **↓**, **←** or **→** button to select [Start].
2. Press the  button.





4 Save the image.

1. Use the **↑**, **↓**, **←** or **→** button to select [New File] or [Overwrite].
2. Press the  button.
 - [New File]: Saved as new file with a new name. The uncorrected image is stored. The new image is stored as the last file.
 - [Overwrite]: Saved with the same file name as the uncorrected image. The uncorrected image is erased.
 - When [New File] is selected, proceed to the procedure 5.



5 Display the saved image.

1. Press the  button.
2. Use the **←** or **→** button to select [Yes].
3. Press the  button.
 - Selecting [No] returns to the Play menu.



- Red-eye correction cannot be performed on movies.
- Overwriting cannot be performed on protected images.



- When there is not enough space left on the memory card, red-eye correction cannot be performed.
- Although you can apply red-eye correction any number of times to an image, the image quality will gradually deteriorate with each application.
- Since the correction frame will not appear automatically on images that have already been corrected once with the Red-Eye Correction function, use the [Add Frame] option to correct them.

Add Correction Frame

1 Select [Add Frame].

1. Use the **↑**, **↓**, **←** or **→** button to select [Add Frame].
2. Press the  button.
 - A green frame will display.



2 Adjust the position of the correction frame.

1. Use the **↑**, **↓**, **←** or **→** button to move the frame.
 - Size of the frame can be changed with the zoom lever.



3 Add additional correction frames.

1. Press the  button.
 - A correction frame is added and the frame color changes to white.
 - If you wish to add additional frames, adjust the position and press the **FUNC./SET** button.
 - Up to 35 additional frames can be added.
 - To end the adding of correction frames, press the **MENU** button.



To correctly perform red-eye correction, take note of the following (refer to the image in step 2):

- Adjust the correction frame size so that it only surrounds the red-eye portion to be corrected.
- When there are several subjects with red-eye, be sure to add one correction frame per subject.

Removing Correction Frames

1 Select [Remove Frame].

1. Use the **↑**, **↓**, **←** or **→** button to select [Remove Frame].
2. Press the  button.



2 Adjust the position of the correction frame.

1. Use the **←** or **→** button to select a frame to remove.
 - The selected frame will appear in green.



3 Delete the frame.

1. Press the  button.
 - The selected frame will disappear.
 - To continue deleting frames, repeat operations from step 2.
 - When you finish deleting frames, press the **MENU** button.

Resizing Images



You can resave images that were recorded at high recording pixel settings at lower settings.

M3	1600 × 1200 pixels
S	640 × 480 pixels
XS	320 × 240 pixels

1 Select [Resize].

1. Press the **MENU** button.
2. In the menu, use the **↑** or **↓** button to select [Resize].
3. Press the **FUNC./SET** button.



2 Select an image.

1. Use the **←** or **→** button to select an image to resize.
 2. Press the **FUNC./SET** button.
- The **FUNC./SET** button is not selectable for images that cannot be resized.



3 Select a resolution.

1. Use the **←** or **→** button to select **M3**, **S** or **XS**.
 2. Press the **FUNC./SET** button.
- Some recording pixel settings cannot be selected depending on the available space of the memory card.





4 Save the image.



1. Use the ◀ or ▶ button to select [OK].
2. Press the  button.
 - The resized image will be saved in a new file.
 - If you wish to continue resizing of another image, repeat operations from step 2.



5 Display the saved image.

1. Press the  button.
2. Use the ◀ or ▶ button to select [Yes].
3. Press the  button.
 - Selecting [No] returns to the Play menu.



 and  mode cannot be resized.

Attaching Sound Memos to Images

In playback mode, you can attach sound memos (up to 1 min.) to an image. The sound data is saved in the WAVE format.

1 Select [Sound Memo].

1. Press the  button.
2. In the  menu, use the ▲ or ▼ button to select [ Sound Memo].
3. Press the  button.

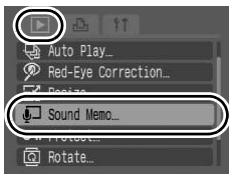

2 Select an image.

1. Use the **←** or **→** button to select an image to which you wish to attach a sound memo.
2. Press the **FUNC./SET** button.
 - The sound memo control panel will display.



3 Record the memo.

1. Use the **←** or **→** button to select **□**.
2. Press the **FUNC./SET** button.
 - The elapsed time and the remaining time display.
 - Pressing the **FUNC./SET** button pauses the recording. Pressing it again resumes recording.
 - Up to 1 minute of recordings can be added to any one image.
 - Press the **MENU** button several times to complete the setting.



Sound Memo Panel

Elapsed Time/
Remaining Time

Volume
(Adjust it with the **↑** or **↓** button)

Sound Memo Panel

Use the **←** or **→** button to select an option and press **FUNC./SET**.

	Exit	Returns to the playback screen.
	Record	Starts recording.
	Pause	Pauses recording or playback.
	Play	Begins playback.
	Erase	Erases sound memos. (Select [Erase] and in the confirmation screen press the FUNC./SET button.)



- You cannot attach sound memos to movies.
- Sound memos for protected images cannot be erased.

Protecting Images



You can protect important images and movies from accidental erasure.

1 Select [Protect].

1. Press the **MENU** button.
2. In the  menu, use the **↑** or **↓** button to select **[Protect]**.
3. Press the  button.



2 Protect an image.

1. Use the **←** or **→** button to select an image to protect.
2. Press the  button.
 - Pressing the **FUNC./SET** button again cancels the setting.
 - You can also protect images in the index playback mode.
 - Press the **MENU** button several times to complete the setting.



Protection Icon

Erasing All Images



You can erase images from a memory card.



- Note that erased images cannot be recovered. Exercise adequate caution before erasing an image.
- Protected images cannot be erased with this function.

1 Select [Erase all].

1. Press the **MENU** button.
2. In the  menu, use the **↑** or **↓** button to select  Erase All].
3. Press the **FUNC. SET** button.



2 Erase the images.

1. Use the **←** or **→** button to select [OK].
 2. Press the **FUNC. SET** button.
- To exit instead of erasing, select [Cancel].



Please format the memory card when you want to erase not only image data but also all the data contained on the memory card (p. 59).

Print Settings/Transfer Settings

Setting the DPOF Print Settings





You can select images on a memory card for printing and specify the number of print copies in advance using the camera. The settings used on the camera comply with the Digital Print Order Format (DPOF) standards. This is extremely convenient for printing on a direct print compatible printer, or for sending the images to a photo developing service that supports DPOF.

The  icon may display for a memory card with print settings set by a different DPOF-compliant camera. These settings will be overwritten by those set by your camera.









Setting the Print Style

After setting the print style, select the images for printing. The following settings can be selected.

* Default setting





Print Type	 Standard*	Prints one image per page.
	 Index	Prints the selected images together at a reduced size in an index format.
	 Both	Prints the images in both the standard and index formats.
 Date (On/Off*)		Adds the date to the print.
 File No. (On/Off*)		Adds the file number to the print.
Clear DPOF data (On*/Off)		Clears all print settings after the images print.

1 Select [Print Settings].



1. Press the  button.
2. Press the  button.
3. Use the  or  button to select the  menu.
4. Use the  or  button to select [Print Settings].
5. Press the  button.



2 Accept the setting.

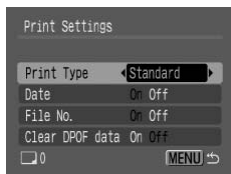







1. Use the  or  button to select [Print Type], [Date], [File No.] or [Clear DPOF data].
2. Use the  or  button to select a setting to configure.
3. Press the  button.



- The Date and File No. settings change according to the Print Type as follows.
 - [Index]
[Date] and [File No.] cannot be set to [On] at the same time.
 - [Standard] or [Both]
[Date] and [File No.] can be set to [On] at the same time, however, the printable information may vary between printers.
- Printing more than two copies
 1. Set [Print Type] in [Print Settings] to [Standard] or [Both].
 2. Select [Select Images & Qty.], choose the image you wish to print, and press the **FUNC./SET** button.
 3. Use the  or  buttons to set the number of copies.
- Images dated using  (Postcard Date Imprint mode) (p. 72) are always printed with the date, regardless of the [Date] setting. As a result, some printers may print the date twice on these images if [Date] is also set to [On].
- Dates print in the style specified in the [Date/Time] menu (p. 12).

Single Images

1 Select [Select Images & Qty.].

1. Press the  button.
2. Press the  button.
3. Use the  or  button to select the  menu.
4. Use the  or  button to select [Select Images & Qty.].
5. Press the  button.

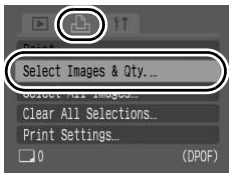







- Selecting [Clear All Selections] cancels all print settings.

2 Select the images.



- Selection methods differ for the Print Type settings (p. 154).

Standard () / Both ()



1. Use the  or  button to select the images.
2. Press the  button.
3. Use the  or  button to select the number of print copies (up to 99).
4. Press the  button.



Number of Print Copies



- If the camera is connected to a printer, the  button will light in blue while images are being selected. At this time, press the  button, confirm that [Print] is selected, and when the **FUNC./SET** button is pressed, printing will begin.

Index (⌘)

1. Use the ◀ or ▶ button to select the images.
2. Select and deselect with the  button.
3. Press the  button.





- You can also select images in the index playback mode.
- If the camera is connected to a printer, the  button will light in blue while images are being selected. At this time, press the  button, confirm that [Print] is selected, and when the **FUNC./SET** button is pressed, printing will begin.

Index Print Selection





All the Images on a Memory Card

1 Select [Select All Images].

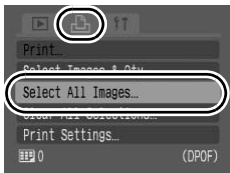
1. Press the  button.
2. Press the  button.
3. Use the ◀ or ▶ button to select the  menu.
4. Use the ▲ or ▼ button to select [Select All Images].
5. Press the  button.



- One copy of every image will be set to print.
- Selecting [Clear All Selections] cancels all print settings.
- When the camera is connected to a printer, the  button will light blue. At this time, press the  button, confirm that [Print] is selected, and when the **FUNC./SET** button is pressed, printing will begin.

2 Select [OK].

1. Use the ◀ or ▶ button to select [OK].
2. Press the  button.

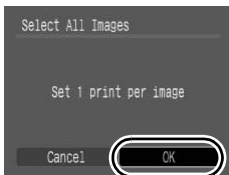

- The output of some printers or photo developing services may not reflect the specified print settings.
- Print settings cannot be set for movies.



- Images are printed in order according to the file number.
- A maximum of 998 images can be selected.
- When [Print Type] is set to [Both], the number of copies can be set. When it is set to [Index], the number of copies cannot be set (only one copy will be printed).

Setting the DPOF Transfer Settings

You can use the camera to specify settings for images before downloading to a computer. Refer to the *Software Starter Guide* for instructions on how to transfer images to your computer.

The settings used on the camera comply with the DPOF standards.

The  icon may display for a memory card with transfer settings set by a different DPOF-compliant camera. These settings will be overwritten by those set by your camera.



Single Images

1 Select [Transfer Order].

1. Press the  button.
2. Press the  button.
3. In the  menu, use the  or  button to select  [Transfer Order].
4. Press the  button.







2 Select [Order].

1. Use the  or  button to select [Order].
 2. Press the  button.
- Selecting [Reset] cancels all transfer order settings.



3 Select the images.

1. Use the  or  button to select images to transfer.
2. Press the  button.
 - Pressing the **FUNC./SET** button again deselects the setting.
 - You can also select images in the index playback mode.
3. Press the  button several times.





All the Images on a Memory Card

1 Select [Transfer Order].

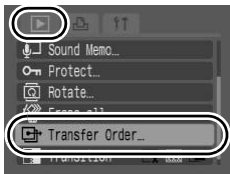
1. Press the  button.
2. In the  menu, use the  or  button to select  Transfer Order].
3. Press the  button.







2 Select [Mark all].

1. Use the  or  button to select [Mark all].
2. Press the  button.
 - Selecting [Reset] cancels all transfer order settings.



3 Select [OK].

1. Use the  or  button to select [OK].
2. Press the  button.
3. Press the  button several times.

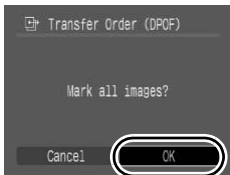

- Images are transferred in order according to the file number.
- A maximum of 998 images can be selected.

Connecting to a TV

Shooting/Playback Using a TV



You can use the supplied AV cable to shoot or playback images using a TV.

1 Turn off the camera and the TV.

2 Connect the AV cable to the camera's A/V OUT terminal.

- Open the terminal cover by sliding to the left and plug the AV cable in all the way.

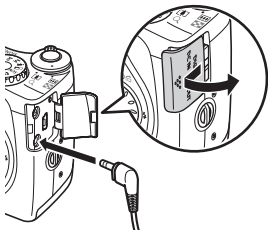

3 Plug the other ends of the AV cable to the VIDEO IN and AUDIO IN jacks on the TV.

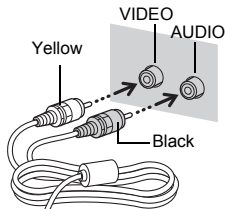

4 Turn on the TV and switch it to video mode.

5 Turn on the camera.



- The video output signal can be switched (NTSC or PAL) to accommodate different regional standards (p. 50). The default setting varies between regions.
 - NTSC: Japan, U.S.A., Canada, Taiwan and others
 - PAL: Europe, Asia (excluding Taiwan), Oceania and others
- If the video system is set incorrectly, the camera output may not display properly.

Troubleshooting

- *Camera* (p. 162).
- *When the power is turned on* (p. 163).
- *LCD monitor* (p. 163).
- *Shooting* (p. 165).
- *Shooting movies* (p. 168).
- *Playback* (p. 169).
- *Battery* (p. 170).
- *TV monitor output* (p. 171).
- *Printing with a direct print compatible printer* (p. 171).

Camera

Camera will not operate.

Power is not turned on.	● Press the power button (p. 12).
Memory card slot/battery cover is open.	● Confirm that the Memory card slot / battery cover is securely closed (p. 9).
Batteries are loaded in the wrong direction.	● Reload the batteries in the correct direction (p. 8).
Batteries are not the right type.	● Use only unused AA-size alkaline batteries or Canon AA-size NiMH batteries (p. 182).
Battery charge is low and the camera will not operate. ("Change the batteries" message displays).	● Replace the camera batteries with two unused or fully charged batteries (p. 8). ● Use the AC Adapter Kit ACK800 (sold separately) (pp. 34, 186).
Poor contact between camera and battery terminals.	● Wipe the battery terminals with a clean dry cloth. ● Reload the batteries several times.

Sounds come from the camera interior.

The camera's horizontal/vertical orientation was changed.

- The camera's orientation mechanism is operating. There is no malfunction.

When the power is turned on**“Card locked!” message appears.**

The SD memory card's or SDHC memory card's write protect tab is set to “Write protect”.

- When recording to, erasing from or formatting the memory card, slide the write protect tab upward (p. 184).

The Date/Time menu appears.

The lithium date battery charge is depleted.

- Replace the lithium date battery (p. 191).

The battery holder was removed.

- The date and time settings need to be reset since they were lost (p. 12).

LCD monitor**The display darkens.**

The image in the LCD monitor will darken in strong sunlight or bright light.

- This is a normal occurrence in devices containing CCDs and does not constitute a malfunction. This image will not be recorded when shooting still photos, but it will be recorded when shooting movies.

Display flickers.

Display flickers when shot under fluorescent lighting.

- This is not a camera malfunction (flickering recorded in movies, but not in still images).

A bar of light (purplish red) appears on the LCD monitor.

Sometimes appears when shooting a bright subject, such as the sun or other light source.

- This is a normal occurrence in devices containing CCDs and does not constitute a malfunction. This bar of light will not be recorded when shooting still photos, but it will be recorded when shooting movies.

appears.

A slow shutter speed has likely been selected because of insufficient lighting.

- Set the IS Mode to any setting other than [Off] (p. 73).
- Raise the ISO speed (p. 110).
- Set the Auto ISO Shift to any setting other than [Off] (p. 111).
- Select a setting other than  (flash off) (p. 111).
- Set the self-timer and attach the camera to a tripod or other device (p. 65).

appears.

This displays when using a memory card that has print settings or transfer settings set by other DPOF-compliant cameras.

- These settings will be overwritten by those set by your camera (pp. 154, 159).

Noise displays./Subject's movements are irregular.

Camera automatically lightened the image displayed on the LCD monitor to make it easier to see when shooting in a dark area (p. 51).

- There is no effect on the recorded image.



Shooting

Camera will not record.

Camera is in playback mode or connecting to a computer/printer mode.	<ul style="list-style-type: none"> ● Switch to Shooting mode (p. 14). ● Switch to the shooting mode after disconnecting the interface cable in connecting to a computer/printer mode.
Flash is charging.	<ul style="list-style-type: none"> ● When the flash is charged, the indicator will light orange. Shooting is now possible (p. 43).
Memory card is full.	<ul style="list-style-type: none"> ● Insert a new memory card (p. 10). ● If required, download the images to a computer and erase them from the memory card to make space.
Memory card is not formatted correctly.	<ul style="list-style-type: none"> ● Format the memory card (p. 59). ● If reformatting does not work, the memory card logic circuits may be damaged. Consult the nearest Canon Customer Support Help Desk.
SD memory card or SDHC memory card is write protected.	<ul style="list-style-type: none"> ● Slide the write protect tab upward (p. 184).

Image is blurred or out of focus.

The camera moves when the shutter button is pressed.	<ul style="list-style-type: none"> ● Confirm the procedures in “ appears” (p. 164).
AF-assist Beam is set to [Off].	<ul style="list-style-type: none"> ● In dark places where it is difficult for the camera to focus, the AF-assist Beam will emit to assist focusing. As the AF-assist Beam will not function when turned off, set it [On] to activate it (p. 47). Take care not to obstruct the AF-assist Beam with your hand when used.

Subject is out of focal range.	<ul style="list-style-type: none"> ● Shoot with the subject at the correct focusing distance (p. 194). ● The camera may be set to an unintended function (such as  (Macro) or  (Manual Focus)). Cancel the setting.
The subject is hard to focus on.	<ul style="list-style-type: none"> ● Use the focus lock, AF lock or manual focus to shoot (p. 103).

Subject in recorded image is too dark.

Insufficient light for shooting.	<ul style="list-style-type: none"> ● Raise the built-in flash to  (Flash on) (p. 65).
The subject is underexposed because the surroundings are too bright.	<ul style="list-style-type: none"> ● Set the exposure compensation to a positive (+) setting (p. 114). ● Use the AE Lock or spot metering functions (pp. 107, 115).
Subject is too far away for flash to reach.	<ul style="list-style-type: none"> ● Shoot within correct flash range of the subject when using the built-in flash (p. 195). ● Raise the ISO speed and then shoot (p. 110).

Subject in recorded image is too bright, or image flashes white.

Subject is too close, making the flash too strong.	<ul style="list-style-type: none"> ● Shoot within correct flash range of the subject when using the built-in flash (p. 195). ● Adjust the flash output with the flash exposure compensation function (p. 121). ● Turn [On] the Safety FE (p. 124).
The subject is overexposed because the surroundings are too dark.	<ul style="list-style-type: none"> ● Set the exposure compensation to a negative (-) setting (p. 114). ● Use the AE Lock or spot metering functions (pp. 107, 115).
Too much light is shining directly into the camera, or is being reflected off the subject.	<ul style="list-style-type: none"> ● Change the shooting angle.

Flash is set to  (Flash on).







- Push down the flash to  (Flash off) (p. 65).

Image contains noise.

ISO speed is too high.

- Higher ISO speeds and  (High ISO Auto) setting may increase image noise. For higher image quality, use as low an ISO speed as possible (p. 110).
- In , , and , , modes in the **SCN** mode or when using the Auto ISO Shift, the ISO speed increases and noise can appear.

White dots appear on the image.

Light from the flash has reflected off dust particles or insects in the air. This is particularly noticeable when shooting using the wide angle or when you increase the aperture value in the aperture-priority **Av** mode.

- This is a phenomenon that occurs with digital cameras and does not constitute a malfunction.

Eyes appear red.

Light is reflected back from the eyes when the flash is used in dark areas.

- Turn [On] the Red-Eye setting in the Rec. menu (p. 93). For this mode to be effective, the subject must be looking right at the red-eye reduction lamp. Try asking them to look directly at the lamp. Even better results can be obtained by increasing the lighting in indoor settings or approaching closer to the subject.
- You can correct red eyes in images using the Red-Eye Correction function (p. 144).

Continuous shooting slows down.

The memory card's performance has dropped.

- To enhance the continuous shooting performance, you are recommended to format the memory card in the camera after you save all its images to your computer (p. 59).

Recording images to memory card takes a long time.

Memory card was formatted in another device.

- Use a memory card formatted in your camera (p. 59).

Lens will not retract.

Memory card slot/battery cover was opened with power on.

- After closing the memory card slot/battery cover, turn the power on then back off (p. 9).

Shooting movies**The recording time may not display properly or shooting may stop unexpectedly.**

The following types of memory cards are used.

- Slow recording memory cards.
- Memory cards formatted on a different camera or a computer.
- Memory cards which have had images recorded and erased repeatedly.

- Although the recording time may not display properly during shooting, the movie will be recorded correctly on the memory card. Recording time will display properly if you format the memory card in this camera (excluding slow recording memory cards) (p. 59).

“!” displayed on the LCD monitor in red and shooting automatically stopped.

There is insufficient free space in the camera's built-in memory.

- Try the following procedures.
 - Format the memory card with a low level format before shooting (p. 59)
 - Lower the recording pixels (p. 82)
 - Use a high-speed memory card (SDC-512MSH, etc.)

Zoom does not operate.

Zoom lever was pressed while shooting in movie mode.

- Operate the zoom before shooting in movie mode (p. 60). Note the digital zoom is available while shooting, but only in Standard movie mode.

Playback

Cannot play back.

You attempted to play back images shot with another camera or images edited with a computer.

- Computer images that cannot be played back may play back if they are added to the camera using the supplied software program ZoomBrowser EX or ImageBrowser. See *ZoomBrowser EX/ImageBrowser Software User Guide* (PDF).

File name was changed with a computer or file location was changed.

- Set the file name or location on the file format/structure of the camera. Refer to the *Software Starter Guide* for details.

Images cannot be edited.

Some images shot with another camera cannot be edited.

Movies do not play back correctly.

Movies recorded with high recording pixels may momentarily stop playing if played on slow reading memory cards.

You may experience frame dropping and audio breakup when playing back a movie on a computer with insufficient system resources.

Images shot with this camera may not play back properly on other cameras.

Reading images from memory card is slow.

- | | |
|--|---|
| Memory card was formatted in another device. | ● Use a memory card formatted in your camera (p. 59). |
|--|---|

Battery

Batteries consumed quickly.

- | | |
|---|--|
| Battery is not being used to its full capacity. | ● See <i>Battery Handling Precautions</i> (p. 182). |
| Batteries are not the right type. | ● Use only unused AA-size alkaline batteries or Canon AA-size NiMH batteries (p. 182). |
| Battery capacity drops due to low ambient temperatures. | ● If shooting in a cold location, warm the batteries such as by placing them in your pocket before using them. |
| Battery terminals are dirty. | ● Wipe the terminals well with a dry cloth before use.
● Reload the batteries several times. |

If using Canon AA-size NiMH batteries

- | | |
|---|--|
| As the batteries have not been used for over a year, their recharging capacity has decreased. | ● Their charging performance should return to normal after fully recharging and fully depleting them over several times. |
| Battery life has been exceeded. | ● Replace both batteries with new ones. |

TV monitor output

Image is distorted or not showing on TV monitor.

Incorrect video system setting.	<ul style="list-style-type: none"> ● Set the video system to the appropriate setting, NTSC or PAL, for your TV (p. 161).
Shooting in Stitch Assist mode.	<ul style="list-style-type: none"> ● The output will not appear on a TV in Stitch Assist mode. Shoot in a different shooting mode (p. 84).

Printing with a direct print compatible printer

Cannot print

The camera and printer are not properly connected.	<ul style="list-style-type: none"> ● Securely connect the camera and printer with the specified cable.
The printer power is not turned on.	<ul style="list-style-type: none"> ● Turn on the printer power.
The print connection method is not correct.	<ul style="list-style-type: none"> ● In the [1] menu, select [Print Method] and select [Auto] (p. 50).

List of Messages

The following messages may appear on the LCD monitor during shooting or playback. Please refer to the *Direct Print User Guide* for the messages that display during a printer connection.

Busy...

Image is being recorded to the memory card, or the playback mode is starting up.

Resetting all the camera and menu settings to default.

No memory card

You turned on the camera without a memory card installed, or with a memory card installed in the wrong orientation (p. 10).

Card locked!

The SD memory card or SDHC memory card is write-protected (p. 10).

Cannot record!

You attempted to shoot an image without a memory card installed, with a memory card installed in the wrong orientation, or attempted to attach a sound memo to a movie.

Memory card error

There may be something wrong with the memory card. By formatting the malfunctioning memory card with the camera, you may be able to continue using it. However, if this error message appears even when using the supplied memory card, contact your Canon Customer Support Help Desk as there may be a problem with the camera.

Memory card full

Memory card is full of images and no more can be recorded or saved, or no more image settings, sound recorder files or sound memos can be recorded.

Naming error!

The file name could not be created because there is an image with the same name as the folder that the camera is attempting to create, or the highest possible file number has already been reached. In the Set up menu, set [File Numbering] to [Auto Reset]; alternatively, save all the images you wish to retain onto a computer, then reformat the memory card. Please note that formatting will erase all the existing images and other data.

Change the batteries

Battery charge is insufficient to operate the camera. Replace both batteries immediately with unused AA-size alkaline batteries or fully charged Canon AA-size NiMH batteries.

Also refer to *Battery Handling Precautions* (p. 182).

No image.

No images recorded on memory card.

Image too large.

You attempted to play back an image larger than 5616 × 3744 pixels or with a large data size.

Incompatible JPEG

You attempted to play back an incompatible JPEG image (edited with a computer, etc.).

RAW

You attempted to play back a RAW image.

Unidentified Image

You attempted to play back an image with corrupted data, an image with a recording type specific to another manufacturer's camera, or an image that has been downloaded to a computer and altered.

Cannot magnify!

You attempted to magnify an image recorded in a different camera or data type, an image edited with a computer, or a movie.

Cannot rotate

You attempted to rotate the image shot with a different camera or data type, or an image edited with a computer.

Incompatible WAVE

A sound memo cannot be added to this image since the data type of the existing sound memo is incorrect. In addition, sound cannot be played back.

Cannot modify image

You attempted to resize or perform red eye correction on a movie or an image recorded with another camera.

Or you attempted to resize an image already resized to **XS** or an image shot in **W**.

Cannot Modify

Cannot apply red-eye correction as no red-eye is detected.

Cannot transfer!

When transferring images to your computer using the Direct Transfer menu, you attempted to select an image with corrupted data or an image taken with another camera. You may have also attempted to select a movie when [Wallpaper] was selected in the Direct Transfer menu.

Protected!

You attempted to erase a protected image, movie or sound memo.

Too many marks.

Too many images have been marked with print settings or transfer settings. Cannot process any more.

Cannot complete!

Could not save a part of the print or transfer settings.

Unselectable image.

You attempted to set the print settings for a non-JPEG image.

Communication error

The computer was unable to download the image due to the large amount of images (approx. 1000) stored on the memory card. Use a USB card reader or PC card adapter to download the images.

Lens error, restart camera

An error was detected while the lens was in motion, and the power has been automatically turned off. This error can occur if you hold the lens while it is in motion or you operate it in a location with excessive dust or sand in the air. Try turning the power back on, and resume shooting or playback. If this message continues to display, contact your Canon Customer Support Help Desk as there may be a problem with the lens.

Exx

(xx: number) Camera detected error. Turn the power off and then back on, then shoot or play back. A problem exists if the error code reappears. Note the number and contact your Canon Customer Support Help Desk. If an error code displays directly after taking a picture, the shot may not have been recorded. Check image in playback mode.

Appendix

Safety Precautions

- Before using the camera, please ensure that you read the safety precautions described below and in the “Safety Precautions” section. Always ensure that the camera is operated correctly.
- The safety precautions noted on the following pages are intended to instruct you in the safe and correct operation of the camera and its accessories to prevent injuries or damage to yourself, other persons and equipment.
- Equipment refers to the camera, battery, battery charger (sold separately) and compact power adapter (sold separately).

Warnings

Equipment

- **Do not point the camera directly at the sun or bright light sources.**

- Doing so could damage the camera's CCD.

- **Store this equipment out of the reach of children and infants. Accidental damage by a child could result in serious injury.**

- Wrist strap: Placement of the strap around the child's neck could result in asphyxiation.

- Memory card: It may be swallowed accidentally. If this occurs, contact a doctor immediately.

- **Do not attempt to disassemble or alter any part of the equipment that is not expressly described in this guide.**

- **To avoid the risk of high-voltage electrical shock, do not touch the flash portion of the camera if it has been damaged.**

- **Stop operating the equipment immediately if it emits smoke or noxious fumes.**

- **Do not allow the equipment to come into contact with, or become immersed in, water or other liquids. If the exterior comes into contact with liquids or salt air, wipe it dry with a soft, absorbent cloth.**

Continued use of the equipment may result in fire or electrical shock.

Immediately turn the camera power off and remove the camera batteries or unplug the battery charger or compact power adapter from the power outlet. Please consult your camera distributor or the closest Canon Customer Support Help Desk.

Equipment

- **Do not use substances containing alcohol, benzene, thinners or other flammable substances to clean or maintain the equipment.**
- **Do not cut, damage, alter or place heavy items on the power cord.**
- **Use only recommended power accessories.**
- **Remove the power cord on a regular periodic basis and wipe away the dust and dirt that collects on the plug, the exterior of the power outlet and the surrounding area.**
- **Do not handle the power cord if your hands are wet.**

Continued use of the equipment may result in fire or electrical shock.

Battery

- **Do not place the batteries near a heat source or expose it to direct flame or heat.**
- **The batteries should not be immersed in water or sea water.**
- **Do not attempt to disassemble, alter or apply heat to the batteries.**
- **Avoid dropping or subjecting the batteries to severe impacts that could damage the casing.**
- **Use only recommended batteries and accessories.**

Failure to follow these precautions may cause explosions or leaks, resulting in fire, injury and damage to the surroundings. In the event that a battery leaks and the eyes, mouth, skin or clothing contact these substances, immediately flush with water and seek medical assistance.

- **Disconnect the battery charger and compact power adapter from both the camera and the power outlet after recharging or when not in use to avoid fire and other hazards.**
- **Do not place anything, such as tablecloths, carpets, bedding or cushions, on top of the battery charger while it is charging.**

Leaving the units plugged in for a long period of time may cause them to overheat and distort, resulting in fire.

Battery

- **When recharging the Canon AA-size NiMH batteries, use only a specified battery charger.**
- **The compact power adapter is designed for exclusive use with this equipment. Do not use it with other products.**

There is a risk of overheating and distortion which could result in fire or electrical shock.

- **Before you discard a battery, cover the terminals with tape or other insulators to prevent direct contact with other objects.**

Contact with the metallic components of other materials in waste containers may lead to fire or explosions.

Others

- **Do not trigger the flash in close proximity to human or animal eyes. Exposure to the intense light produced by the flash may damage eyesight.**

In particular, remain at least one meter (39 inches) away from infants when using the flash.

- **Keep objects that are sensitive to magnetic fields (such as credit cards) away from the speaker of the camera.**

Such items may lose data or stop working.

⚠ Cautions

Equipment

- **Be careful not to bang the camera or subject it to strong impacts or shocks that could lead to injury or damage the equipment when wearing or holding it by the strap.**
- **Be careful not to bump or strongly push the end of the lens.**
The above-mentioned could lead to injury or damage the equipment.
- **Do not store the equipment in humid or dusty areas.**
- **During shooting, do not allow metal objects (such as pins or keys) or dirt to contact the charger terminals or plug.**
Such conditions could lead to fire, electrical shock or other damage.
- **Avoid using, placing or storing the equipment in places subject to strong sunlight or high temperatures, such as the dashboard or trunk (boot) of a car.**
- **Do not use the equipment in a manner that exceeds the rated capacity of the electrical outlet or wiring accessories. Or, do not use the equipment if the cable or plug is damaged, or if the plug is not fully inserted into the power outlet.**
- **Do not use in locations with poor ventilation.**
The above-mentioned can cause leakage, overheating or explosion, resulting in fire, burns or other injuries. High temperatures may also cause deformation of the casing.
- **When not using the camera for extended periods of time, remove the batteries from the camera or battery charger and store the equipment in a safe place.**
If the batteries are left inside the camera, damage caused by leakage may occur.
- **Do not connect compact power adapters or battery chargers to devices such as electrical transformers for foreign travel because it may lead to malfunctions, excessive heat generation, fire, electric shock or injury.**

Flash

- **Do not operate the flash with dirt, dust or other items stuck to the surface of the flash.**
- **Be careful not to cover the flash with your fingers or clothing when shooting.**

The flash may be damaged and emit smoke or noise. The resulting heat build-up could damage the flash.

- **Do not touch the surface of the flash after taking several pictures in rapid succession.**

Doing so could result in burns.

Preventing Malfunctions

Avoid Strong Magnetic Fields

- **Never place the camera in close proximity to electric motors or other equipment generating strong electromagnetic fields.**

Exposure to strong magnetic fields may cause malfunctions or corrupt image data.

Avoid Condensation Related Problems

- **When moving the equipment rapidly from cold to hot temperatures, you can avoid condensation by placing the equipment in an airtight, resealable plastic bag and letting it adjust to temperature changes slowly before removing it from the bag.**

Moving the equipment rapidly from cold to hot temperatures may cause condensation (water droplets) to form on its external and internal surfaces.

If Condensation Forms Inside the Camera

- **Stop using the camera immediately.**

Continued use may damage the equipment. Remove the memory card and batteries or compact power adapter from the camera and wait until the moisture evaporates completely before resuming use.

Battery Handling

Battery Charge

The following icon and message will display.



Battery charge is low. If using the camera for an extended period, replace the batteries as soon as possible.

Change the batteries

Batteries are fully depleted and the camera can no longer operate. Replace the batteries immediately.

Battery Handling Precautions

- **This camera uses AA-size alkaline batteries or Canon AA-size NiMH batteries (sold separately).**

While it is possible to use AA-size nickel-cadmium batteries, performance is unreliable and their use is not recommended.

- **Since the performance of alkaline batteries may differ according to brand, the operating time of the batteries you purchase may not be as long as the batteries that came with the camera.**
- **When using the camera under low temperature conditions or over long periods, you are recommend to use of Canon AA-size NiMH batteries (sold separately).**

Camera operating time may shorten at low temperatures when alkaline batteries are used. Also due to their specifications, alkaline batteries may expire faster than NiMH batteries.

- **Never mix unused and partially used batteries.**

The partially used batteries may leak.

- **Do not install the batteries with their terminals (⊕ and ⊖) reversed.**
- **Do not mix batteries of different types or from different manufacturers.**

- **Before installing the batteries, wipe the battery terminals well with a dry cloth.**

If the battery terminals are soiled with oil from one's skin or other dirt, the number of recordable images may be considerably diminished, or the amount of time the camera can be used may be reduced.

- **At low temperatures, battery performance may be reduced and the low battery icon (🔋) may appear earlier than usual.**

Under these conditions, restore the battery performance by warming it in a pocket immediately before use.

- **Do not put the batteries into a pocket together with metallic items such as a key ring.**

The batteries may be short circuited.

- **When not using the camera for long periods, remove the batteries from the camera and store them separately.**

If the batteries are left inside the camera, the camera may become damaged from battery leakage.

WARNING

Never use damaged batteries or batteries whose outer seal is completely or partially missing or peeled off, as there is risk that such batteries may leak, overheat, or burst. Always check the seals on store-bought batteries before loading them, as some batteries may come with defective seals. Do not use batteries with defective seals.

Never use batteries that look like this.



Batteries with all or part of the seal (electrical insulation sheath) peeled off.



The positive electrode (plus terminal) is flat.



The negative terminal is correctly formed (protruding from the metal base), but the seal does not extend up over the edge of the metal base.

Handling the Memory Card

SD Memory Card or SDHC Memory Card Write Protect Tab

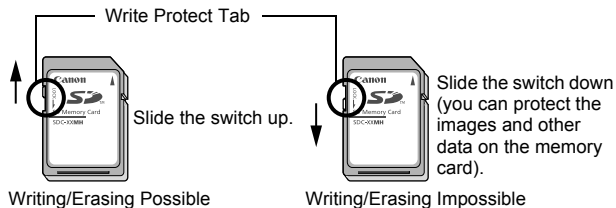

Cautions When Handling

- Memory cards are high-precision electronic devices. Do not bend them, apply force to them, or subject them to shocks or vibration.
- Do not attempt to disassemble or alter the memory card.
- Do not allow dirt, water or foreign objects to contact the terminals on the back of the memory card. Do not touch the terminals with your hands or metal objects.
- Do not peel away the original label on the memory card or cover it with another label or sticker.
- When writing on the memory card, do not use a pencil or ball-point pen. Only use a soft point pen (e.g. felt-tip pen).
- Do not use or store memory cards in the following locations.
 - Locations subject to dust or sand
 - Locations subject to high humidity and high temperatures
- Since some or all of the data recorded on the memory card may be corrupted or erased by electrical noise, static electricity, camera or memory card malfunction, making a backup copy of important data is recommended.

Formatting

- **Please note that formatting (initializing) an memory card erases all data, including protected images.**
- **You are recommended to use memory cards that have been formatted in your camera.**
 - The memory card supplied with the camera may be used without further formatting.
 - When the camera is malfunctioning, a corrupted memory card might be the cause. Reformatting the memory card may solve the problem.
 - When a non-Canon brand memory card is malfunctioning, reformatting it may solve the problem.
 - Memory cards formatted in other cameras, computers, or peripheral devices may not operate correctly in this camera. When that happens, reformat the memory card with this camera.
- **If formatting in the camera does not work properly, turn the camera off and re-insert the memory card. Then turn the camera back on and format again.**
- **Be careful when transferring or disposing of a memory card. Formatting or erasing the data on a memory card merely changes the file management information on the memory card and does not ensure that its contents are completely deleted. When disposing of a memory card, take precautions, such as physically destroying the memory card, to prevent personal information leaks.**

Using the Power Kits (Sold Separately)

Using Rechargeable Batteries (Battery and Charger Kit CBK4-300)

This kit includes a battery charger and four rechargeable AA-size NiMH (nickel metal hydride) batteries. Charge batteries as shown below.

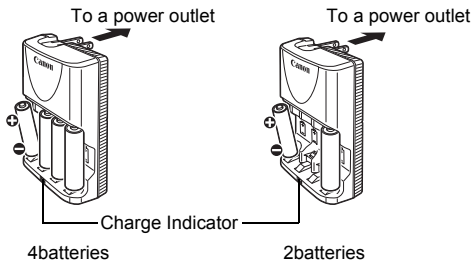

- After inserting the batteries, plug the charger (CB-5AH) into an outlet, or attach the power cord to the charger (CB-5AHE, not shown) and plug the other end into an outlet.
- Do not insert and charge additional batteries once charging has begun.
- The charge indicator blinks while charging, then remains lit when charging is finished.



- The CB-5AH/CB-5AHE battery charger can only be used to charge Canon AA-size NiMH batteries NB-3AH and NB-2AH. Please do not attempt to charge other type of battery.
- Do not mix batteries with different purchase dates or different charge states. When recharging batteries, always recharge both of them at the same time.
- Do not attempt to recharge fully charged batteries, as doing so may reduce or impair battery performance. Also, do not charge batteries for more than 24 consecutive hours.
- Do not recharge batteries in enclosed areas that tend to retain heat.
- Do not recharge the batteries until the LCD monitor displays the "Change the batteries" message. Repeatedly recharging batteries before they become fully depleted may cause batteries to lose capacity.



- Wipe the battery terminals well with a dry cloth in the following situations, as the terminals may be soiled with oil from one's skin or other dirt:
 - If the battery usage time has considerably diminished
 - If the number of recordable images has considerably diminished
 - When charging the batteries (insert and remove the batteries two or three times before charging)
 - When charging completes in a space of a few minutes (the battery charger indicator remains lit)
- You may not be able to fully charge the batteries due to their specifications right after purchase or after long periods of nonuse. If this happens, after fully charging them, use the batteries until their charge is depleted. After doing this several times, battery performance will be restored.
- If you store batteries for a long period of time (about 1 year), it is recommended that you fully deplete the batteries in the camera and to then store them at room temperature (0 to 30°C/32 to 90°F) in low humidity. Storing them in a fully charged condition can shorten their lifespan or degrade their performance.

Again, if you do not use batteries for more than 1 year, fully charge them once a year and deplete them in the camera before storing them.
- If the battery usage time has become considerably low despite wiping the terminals and charging them until the battery charger indicator remains lit, this may indicate that the batteries have reached the end of their lifespan. Replace them with new batteries. If you are purchasing new batteries, look for Canon AA-size NiMH batteries.
- Leaving batteries in the camera or charger may result in damage from battery leakage. When not in use, remove the batteries from the camera or charger and store them in a cool, dry location.



- It takes approximately 4 hours 40 minutes for the charger to fully recharge the batteries after they have been depleted. When two batteries are placed on each side of the charger, recharging will take approximately two hours (as determined by testing at Canon facilities). Charge batteries in an environment where the temperature is in the range of 0 to 35°C (32 to 95°F).
- The charging time varies according to the ambient temperature and to the battery charge state.
- The battery charger may emit noise while charging. This is not a malfunction.
- Battery/Charger Kit CBK4-200 can also be used.

Using the AC Adapter Kit ACK800

It is best to power the camera with AC Adapter Kit ACK800 (sold separately) when you are using it for long periods of time or connecting it to a computer.



Turn the camera power off before connecting or disconnecting the AC adapter.

- 1 Connect the power cord to the compact power adapter first and then plug the other end into the power outlet.**

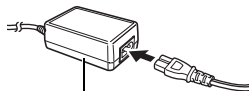

Compact Power Adapter
CA-PS800

- 2 Open the terminal cover by sliding to the left and attach the cord to the DC IN terminal.**

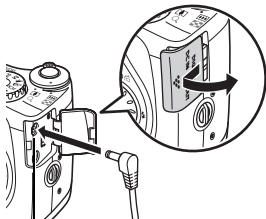

DC IN terminal

Using an Externally Mounted Flash (Sold Separately)

High-Power Flash HF-DC1

This flash is used to supplement the camera's built-in flash when the subject is too far away for proper illumination. Use the following procedures to affix the camera and High-Power Flash to the supporting bracket.

Please read the instructions accompanying the flash along with this explanation.

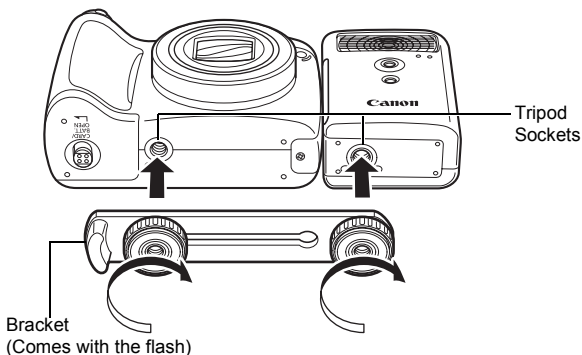

- The High-Power Flash will not fire in the following situations:
 - When shooting in **M** mode
 - When Flash Adjust is set to [Manual]
- The flash charge time will lengthen as the battery charge gets weaker. Always set the power/mode switch to [OFF] when you finish using the flash.
- Be careful not to touch the flash window or sensor windows with your fingers while the flash is in use.
- The flash may fire if another flash is being used in close proximity.
- The High-Power Flash may not fire outdoors in daylight or when there are no reflective items.

- For continuous shooting, although the flash fires for the first shot, it does not fire for subsequent shots.
- Fasten the attachment screws securely so that they do not loosen. Failure to do so may lead to the dropping of the camera and flash resulting in damage to both.



- Before attaching the bracket to the flash, check that the lithium battery (CR123A or DL123) is installed.
- To illuminate the subjects properly, install the flash so that it is up against the side of the camera and parallel with the camera's front panel.
- A tripod can be used even when the flash is attached.

■ Batteries

● Charge becomes Severely Limited

If the battery usage time has considerably diminished, wipe the battery terminals well with a dry cloth. The terminals may be dirty from fingerprints.

● Usage in Cold Temperatures

Get a spare generic lithium battery (CR123A or DL123). You are recommended to place the spare battery in your pocket to warm it up before switching it for the battery in the flash.

● Non-Use over Extended Periods

Leaving batteries in the High-Power Flash could allow the battery fluid to leak, damaging the product. Remove the batteries from the High-Power Flash and store them in a cool, dry place.

Replacing the Date Battery

If the Date/Time in the Set up menu appears when the camera power is turned on, the date battery charge is low and the date and time settings have been lost. Please purchase a lithium coin battery (CR1220) and replace it as follows.

The date battery is preinstalled at the factory and may therefore expire earlier than its rated lifespan after the camera has been purchased.



Be particularly careful to keep the date batteries out of the reach of children. Seek medical assistance immediately if a child swallows a battery since corrosive battery fluids could damage the stomach or intestinal wall.

1 Confirm that the camera is turned off.

2 Hook your nail onto the date battery holder and lightly pull it up.

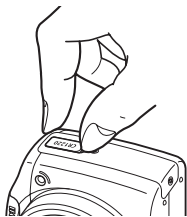

3 Pull out the battery holder in the direction indicated by the arrow.

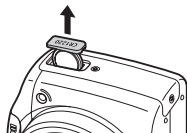

4 Remove the battery by pulling it up in the direction indicated by the arrow.

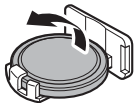

- 5 Insert a new battery with the (-) side facing up.**

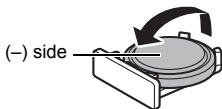

- 6 Replace the battery holder.**

- 7 When the Date/Time menu appears, set the date and time (p. 12).**



After purchasing the camera and turning on the power for the first time, although the Date/Time menu will appear, you do not need to replace the date battery.

If you ever dispose of your camera, first remove the date battery for recycling according to the recycling system of your country.

For CA, USA only

Included lithium battery contains Perchlorate Material - special handling may apply.

See www.dtsc.ca.gov/hazardouswaste/perchlorate/ for details.

Camera Care and Maintenance

Never use thinners, benzine, detergents or water to clean the camera. These substances may distort or damage the equipment.

Camera Body

Gently wipe dirt off the camera body with a soft cloth or eyeglass lens wiper.

Lens

First use a lens blower brush to remove dust and dirt, then remove any remaining dirt by wiping the lens lightly with a soft cloth.



Never use organic solvents on the camera body or lens. If dirt remains, contact the closest Canon Customer Support Help Desk as listed on the customer support list supplied with your camera.

LCD Monitor

Use a lens blower brush to remove dust and dirt. If necessary, gently wipe with a soft cloth or an eyeglass lens wiper to remove stubborn dirt.



Never rub or press strongly on the LCD monitor. These actions may damage it or lead to other problems.

Specifications

All data is based on Canon's standard testing methods. Subject to change without notice.

PowerShot SX100 IS

(W): Max. wide angle (T): Max. telephoto

Camera Effective Pixels	: Approx. 8.0 million
Image Sensor	: 1/2.5-inch type CCD (Total number of pixels: Approx. 8.3 million)
Lens	: 6.0 (W) – 60 (T) mm (35mm film equivalent: 36 (W) – 360 (T) mm) f/2.8 (W) – f/4.3 (T)
Digital Zoom	: Approx. 4.0x (Up to approx. 40x in combination with the optical zoom)
LCD Monitor	: 2.5-inch type, low-temperature polycrystalline silicon TFT color LCD, approx. 172,000 pixels (Picture coverage 100%) with wide viewing angle
AF System	: TTL autofocus AF lock and Manual focus are available AF Frame: Face Detect*/Center** * If no face is detected, center 1-point is used. AF frame can be moved and fixed to specified face. ** Size of AF frame can be selected
Focusing Range (From end of lens)	: Normal: 50 cm (1.6 ft.) – infinity (W), 1 m (3.3 ft.) – infinity (T) Macro: 1 – 50 cm (W) (0.39 in. – 1.6 ft. (W)) Manual focus: 1 cm (0.39 in.) – infinity (W), 1 m (3.3 ft.) – infinity (T) Kids&Pets: 1m – infinity (W/T)
Shutter	: Mechanical shutter + electronic shutter
Shutter Speeds	: 15 – 1/2500 sec. <ul style="list-style-type: none"> • The shutter speed varies depending on the shooting mode. • Slow shutter speeds of 1.3 sec. or slower operate with noise reduction.

Image Stabilization	: Lens shift type Continuous/Shoot Only*/Panning*/Off * Still images only
Metering System	: Evaluative*, Center-weighted average or Spot * When [Face Detect] is selected, the brightness of the face is also evaluated.
Exposure Compensation	: ± 2 stops in 1/3-stop increments Safety Shift is available.
ISO speed (Standard Output Sensitivity, Recommended Exposure Index)	: Auto*, High ISO Auto*, ISO 80/100/200/400/ 800/1600 * Camera automatically sets the optimal speed.
White Balance	: Auto, Day Light, Cloudy, Tungsten, Fluorescent, Fluorescent H or Custom
Built-in Flash	: Auto, on, off Flash output compensation (± 2.0 stops in 1/3-stop increments), Red-Eye Reduction, flash output settings (3 steps), FE Lock, Slow Synchro and Safety FE are available.
Compensation Range of Built-In Flash	: 50 cm – 3.0 m (1.6 – 9.8 ft.) (W), 50 cm – 2.0 m (1.6 – 6.6 ft.) (T) (ISO speed: Auto)
Shooting Modes	: Auto Creative zone: P Program, Tv Shutter-speed priority, Av Aperture priority, M Manual Image zone: Portrait, Landscape, Night Snapshot, Kids&Pets, Special Scene* ¹ , Stitch Assist and Movie* ² * ¹ Night Scene, Indoor, Foliage, Snow, Beach, Fireworks and Aquarium. * ² Standard and Compact.
Continuous Shooting	: Approx. 1.3 shots/sec. (In Large/Fine mode) Approx. 0.8 shots/sec. (Continuous Shooting AF, Large/Fine mode) Approx. 0.8 shots/sec. (Continuous Shooting LV, Large/Fine mode)

Self-timer	: Activates shutter after an approx. 10-sec./ approx. 2-sec. delay, Custom Timer
Recording Media	: SD memory card/SDHC memory card/ MultiMediaCard/MMCplus card/HC MMCplus card
File Format	: Design rule for camera file system and DPOF compliant
Data Type	: Still images: Exif 2.2 (JPEG)* : Movies: AVI (Image data: Motion JPEG; Audio data: WAVE (monaural)) : Sound memos: WAVE (monaural) * This digital camera supports Exif 2.2 (also called "Exif Print"). Exif Print is a standard for enhancing the communication between digital cameras and printers. By connecting to an Exif Print-compliant printer, the camera's image data at the time of shooting is used and optimized, yielding extremely high quality prints.
Compression	: Superfine, Fine, Normal
Number of (Still images) Recording Pixels	: Large: 3264 × 2448 pixels Medium 1: 2592 × 1944 pixels Medium 2: 2048 × 1536 pixels Medium 3: 1600 × 1200 pixels Small: 640 × 480 pixels Postcard: 1600 × 1200 pixels Widescreen: 3264 × 1832 pixels
(Movies)	: Standard: 640 × 480 pixels, 30 frames/sec. 640 × 480 pixels, 30 frames/sec., LP 320 × 240 pixels, 30 frames/sec. Recording can continue until the memory card is full* ¹ (can record up to a maximum of 4 GB at one time)* ² Compact: (can record for 3 min.) 160 × 120 pixels, 15 frames/sec. * ¹ Using super high-speed memory cards (SDC-512 MSH recommended). * ² Even if the clip size has not reached 4 GB, recording will stop at the moment the clip length reaches 1 hour. Depending on the volume and data writing speed of the memory card, recording may stop before reaching 1 hour or before the recorded data volume has reached 4 GB.

Audio	: Quantization Bit Rate: 8 bit Sampling Rate Sound Memos and Movies: 11 kHz
Remote Shooting	: Shooting possible when connected to a computer using supplied software.
Playback Modes	: Single (histogram displayable), Index (9 thumbnail images), Magnified (approx. 10x (max.) in LCD monitor, advance or reverse through magnified images possible), Red-Eye Correction, Jump (it is possible to jump to every tenth or hundredth image, to the first image of each shooting date, to movies or to the first image in each folder. In index playback mode, it displays 9 images at once.), Auto Play, Sound memos (up to 1 min.), Movie (slow motion play back possible) or Resize.
Direct Print	: <i>PictBridge</i> compliant, and <i>Canon Direct Print</i> and <i>Bubble Jet Direct</i> compatible
Interface	: USB 2.0 Hi-Speed (mini-B) Audio/Video output (NTSC or PAL selectable, monaural audio)
Communication Settings	MTP, PTP
Power Source	: 2 AA-size alkaline batteries 2 AA-size NiMH batteries NB4-300 (sold separately) AC Adapter Kit ACK800 (sold separately)
Operating Temperatures	: 0 – 40 °C (32 – 104 °F) (0 – 35 °C (32 – 95 °F) when NB-3AH is used.)
Operating Humidity	: 10 – 90%
Dimensions (excluding protrusions)	: 108.7 × 71.4 × 46.7 mm (4.28 × 2.81 × 1.84 in.)
Weight (camera body only)	: Approx. 265 g (9.35 oz.)

Battery Capacity

	Number of Images Shot	Playback Time
	LCD Monitor On (Based on the CIPA standard)	
AA-size Alkaline Batteries (included with the camera)	Approx. 140 images	Approx. 7 hours
AA-size NiMH Batteries (NB-3AH (fully charged))	Approx. 400 images	Approx. 10 hours

- The actual figures will vary according to the shooting conditions and settings.
- Movie data is excluded.
- At low temperatures, the battery performance may diminish and the low battery icon may appear very rapidly. In these circumstances, the performance can be improved by warming the battery in a pocket before use.

Test Conditions

Shooting: Normal temperature (23°C ±2°C/73°F ±3.6°F), normal relative humidity (50% ±20%), alternating wide angle end and telephoto end shots at 30 second intervals with the flash fired once every two shots and the camera power turned off after every tenth shot. Power is left off for a sufficient amount of time*, then the power is turned back on and the testing procedure is repeated.

- A Canon-brand memory card is used.

- * Until the battery returns to normal temperature





















Playback: Normal temperature (23°C ±2°C/73°F ±3.6°F), normal relative humidity (50% ±20%), continuous playback at 3 seconds per image.



See *Battery Handling Precautions* (p. 182).

Memory Cards and Estimated Capacities



: Memory card included with the camera

Recording Pixels	Compression	16 MB	SDC-128M	SDC-512MSH
L (Large) 3264 × 2448 pixels		3	35	139
		6	59	231
		13	123	479
M1 (Medium 1) 2592 × 1944 pixels		5	49	190
		9	87	339
		19	173	671
M2 (Medium 2) 2048 × 1536 pixels		8	76	295
		15	136	529
		30	269	1041
M3 (Medium 3) 1600 × 1200 pixels		13	121	471
		24	217	839
		47	411	1590
S (Small) 640 × 480 pixels		52	460	1777
		81	711	2747
		128	1118	4317
 (Postcard) 1600 × 1200 pixels		24	217	839
W (Widescreen) 3264 × 1832 pixels		5	47	183
		8	79	307
		18	166	642

-  Capable of smooth continuous shooting (p. 91) when memory card has been formatted with a low level format.
- This reflects standard shooting criteria established by Canon. Actual results may vary according to the subject and shooting conditions.





Movie





: Memory card included with the camera

	Recording Pixels /Frame Rate	16 MB	SDC-128M	SDC-512MSH
 Standard	640 × 480 pixels 30 frames/sec.	6 sec.	1 min. 4 sec.	4 min. 9 sec.
	640 × 480 pixels 30 frames/sec., LP	14 sec.	2 min. 7 sec.	8 min. 14 sec.
	320 × 240 pixels 30 frames/sec.	20 sec.	3 min. 1 sec.	11 min. 42 sec.
 Compact	160 × 120 pixels 15 frames/sec.	1 min. 40 sec.	14 min. 29 sec.	55 min. 57 sec.

- Maximum movie clip length at : 3 min. The figures indicate the maximum continuous recording time.

Image Data Sizes (Estimated)

Recording Pixels	Compression		
			
L 3264 × 2448 pixels	3436 KB	2060 KB	980 KB
M1 2592 × 1944 pixels	2503 KB	1395 KB	695 KB
M2 2048 × 1536 pixels	1602 KB	893 KB	445 KB
M3 1600 × 1200 pixels	1002 KB	558 KB	278 KB
S 640 × 480 pixels	249 KB	150 KB	84 KB
 1600 × 1200 pixels	—	558 KB	—
W 3264 × 1832 pixels	2601 KB	1540 KB	736 KB

	Recording Pixels	Frame Rate	File size
 Standard	 640 × 480 pixels	30 frames/sec.	1920 KB/sec.
		30 frames/sec., LP	960 KB/sec.
	 320 × 240 pixels	30 frames/sec.	660 KB/sec.
 Compact	 160 × 120 pixels	15 frames/sec.	120 KB/sec.

MultiMediaCard

Interface	Compatible with MultiMediaCard standards
Dimensions	32.0 × 24.0 × 1.4 mm (1.3 × 0.9 × 0.06 in.)
Weight	Approx. 1.5 g (0.05 oz.)

SD Memory Card

Interface	Compatible with SD memory card standards
Dimensions	32.0 × 24.0 × 2.1 mm (1.3 × 0.9 × 0.1 in.)
Weight	Approx. 2 g (0.07 oz.)

NiMH Battery NB-3AH

(Supplied with the separately sold NiMH Battery NB4-300 set or the Battery and Charger Kit CBK4-300)

Type	AA-size nickel metal hydride battery
Nominal Voltage	1.2 V DC
Typical Capacity	2500 mAh (min.: 2300 mAh)
Cycle Life	Approx. 300 times
Operating Temperatures	0 – 35 °C (32 – 95 °F)
Diameter × Length	14.5 × 50.0 mm (0.57 × 1.97 in.)
Weight	Approx. 30 g (1.06 oz.)



USA and Canada only:

The Nickel-Metal Hydride battery that powers the product is recyclable.

Please call 1-800-8-BATTERY for information on how to recycle this battery.

Battery Charger CB-5AH/CB-5AHE

(Supplied with the separately sold Battery and Charger Kit CBK4-300)

Rated Input	100 – 240 V AC (50/60 Hz)
Rated Output	565 mA ^{*1} , 1275 mA ^{*2}
Charging Time	Approx. 4 hours 40 min.* ¹ , Approx. 2 hours ^{*2}
Operating Temperatures	0 – 35 °C (32 – 95 °F)
Dimensions	65.0 × 105.0 × 27.5 mm (2.56 × 4.13 × 1.08 in.)
Weight (body only)	Approx. 95 g (3.35 oz.)

*1 When charging four NB-3AH batteries

*2 When charging two NB-3AH batteries loaded one on each side of the battery charger

Compact Power Adapter CA-PS800

(Included with the separately sold AC Adapter Kit ACK800)

Rated Input	100 – 240 V AC (50/ 60 Hz)
Rated Output	3.15 V DC, 2.0 A
Operating Temperatures	0 – 40 °C (32 – 104 °F)
Dimensions	42.6 × 104.0 × 31.4 mm (1.68 × 4.11 × 1.24 in.)
Weight	Approx. 180 g (6.35 oz.) (excluding power cord)

Index

Numerics

3:2 Guide 47, 53, 127

A

AC Adapter Kit ACK800 34, 188
 Accessory (Sold Separately) 34
 ACK800 34, 188
 AE Lock 107
 AF Frame 53, 97, 98
 AF Lock 103, 104
 AF Mode 97
 AF-assist Beam 47, 165
 Aperture Value 87, 88, 89, 90
 Auto
 Shooting 14
 Auto ISO Shift 111
 Auto Play 143
 Auto Power Down 49
 Auto Rotate Function 128
 AV Cable 1

B

Battery
 Battery Capacity 198
 Charging 182
 Handling 182
 Installing 8
 Rechargeable Batteries 186
 Rechargeable Battery 182

C

Camera Care and Maintenance
 193
 Compact Power Adapter
 188, 202
 Components Guide 38

Compression 70
 Continuous Shooting 91
 Control Dial 41
 Correct Frame 144
 Correction Frames
 Add 147
 Removing 148
 Create Folder 129
 Creating an Image Destination
 129
 Creative Zone 75
 Custom White Balance 117

D

Date/Time 12
 Date/Time Setting 12
 Default Values 58
 Detailed 55
 Digital Tele-Converter 61
 DIGITAL Terminal 22, 26
 Digital Zoom 61
 Digital Zoom/Digital
 Tele-Converter 61
 Direct Transfer 29, 30
 Disp. Overlay 47, 127
 Distance Units 49
 Downloading Images to a
 Computer 24
 DPOF
 Print Settings 48
 Transfer Settings 48, 159
 DPOF Print Order
 Print Style 154
 Selecting Images 154
 DPOF Print Settings 154
 DPOF Transfer Order 159
 DPOF Transfer Settings 159

E

Embedding the Date	72
Erasing	153
All Images	153
Single Images	21
Exposure	107, 114
Exposure Compensation	114

F

Face Detect	98
Face Selection	101
Face Selector Button	40
FE Lock	109
File Number	55, 131
Flash	65
Flash Adjustment	122
Flash Exposure Compensation	122
Flash Output	123
Focus	15, 95, 98
Focus Check	95
Focus Check Display	135
Focus Lock	103
Format	59
Formatting	58, 59
Frame Rate	82
FUNC. Menu	46
FUNC./SET	40

G

Grid Lines	47, 53, 127
------------------	-------------

H

HF-DC1	34, 189
High-Power Flash	189
Histogram	57

I

Image Data Sizes (Estimated)	200
---------------------------------------	-----

Image Stabilizer Function	73
Image Zone	75
Index Playback	134
Indicator	43
Information Displayed on the LCD Monitor	51, 53
Interface Cable	1, 22, 26
IS Mode	73
ISO Speed	110, 111

J

Jump	138
------------	-----

K

Kids&Pets	76
-----------------	----

L

Landscape	76
Language	13, 50
LCD Brightness	52
LCD Monitor	
Night Display	52
Playback Information	55
Shooting Information	53
Using the LCD Monitor	51
LCD monitor	
Night Display	52
List of Messages	172

M

Macro	66
Magnifying Images	133
Maintenance	193
Manual	
Focus	103
Shooting Mode	90
White Balance	116
Manual Focus	105
Memory Card	1
Estimated Capacities	199

Formatting	59
Handling	184
Inserting	10
MENU	40, 45
Menu	
FUNC. Menu	44, 46
MENU Button	45
Menus and Settings	44
Play Menu	45, 48
Print Menu	45, 48
Rec. Menu	45, 46
Set up Menu	45, 48
Menu List	46
Messages	172
Metering Mode	115
MF-Point Zoom	47, 105
Microphone	38
Mode Dial	14, 40, 75
Mode Switch	40
Movie	
Playback	20, 139
Recording	18, 79
Shooting	18
Viewing	20
Mute	48
My Colors	119

N

Night Display	52
Night Scene	77
Night Snapshot	76

O

Operation Sound	48
Operation Vol.	48
Optical Zoom	60
Overexposure Warning	57

P

Package Contents	1
------------------------	---

Panorama	83
Play Menu	48
Playback	17, 20
Using a TV	161
Playback Information	55
Playback Mode	55
Playback Vol.	48
Portrait	76
Postcard	71
Power	
Compact Power Adapter	
.....	188, 202
Rechargeable Batteries	186
Power Button	14, 40
Power Saving Function	43, 49
Print Menu	48
Print/Share	125
Print/Share Button	23, 30, 40, 125
Printing	22, 154
Program AE	85
Protecting	152

R

Rec. Menu	46
Rec. Review	16
Recording Pixels	53, 69, 82
Red-Eye	46, 93
Red-Eye Correction	48, 93, 144
Reset All	58
Resize	149
Resume Playback	17
Review	16, 47
Using a TV	161
Rotate	141

S

Safety FE	124
Safety MF	106
Safety Shift	47, 89
Safety Zoom	63
Self-Timer	67

Selftimer Vol.	48	Stitch Assist	83
Set up Menu	48	System Requirements	24
Shooting	14		
Shooting Information	53	T	
Shooting Mode		Telephoto	60
Creative Zone	75	Transition	142
Av	88	Transition Effects	142
M	90	Troubleshooting	162
P	85		
Tv	86	V	
Functions Available	222	Video Output System	50
Image Zone	75, 76	Video System	161
Kids & Pets	76	Volume	48
Landscape	76		
Movie	79	W	
Night Snapshot	76	White Balance	116
Portrait	76	Wide Angle	60
Special Scene	77	Wrist Strap	1, 9
Aquarium	78		
Beach	78	Z	
Fireworks	78	Zoom	60
Foliage	77	Zoom Lever	40
Indoor	77		
Night Scene	77		
Snow	78		
Stitch Assist	83		
Shutter Button			
Pressing Fully	15		
Shutter Speed	86, 90		
Shutter Volume	48		
Slow Synchro Function	46, 94		
Smooth Continuous Shooting ...	91		
Sound Memo	150		
Speaker	38		
Special Scene	77		
Spot AE Point Frame	53, 115		
Standard	55		
Start-up Image	49		
Start-up Vol.	48		
Still Image			
Shooting	14		
Viewing	17		

MEMO

MEMO

MEMO

MEMO

MEMO

MEMO

MEMO

MEMO

MEMO

MEMO

MEMO

MEMO

MEMO

FCC Notice

(Digital Camera, Model PC1256 system)

This device complies with Part 15 of the FCC Rules. Operation is subject to the following two conditions;

- (1) this device may not cause harmful interference, and
- (2) this device must accept any interference received, including interference that may cause undesired operation.

Note: This equipment has been tested and found to comply with the limits for Class B digital devices, pursuant to Part 15 of the FCC rules. These limits are designed to provide reasonable protection against harmful interference in a residential installation. This equipment generates, uses and can radiate radio frequency energy and, if not installed and used in accordance with the instructions, may cause harmful interference to radio communications. However, there is no guarantee that interference will not occur in a particular installation. If this equipment does cause harmful interference to radio or television reception, which can be determined by turning the equipment off and on, the user is encouraged to try to correct the interference by one or more of the following measures:

- Reorient or relocate the receiving antenna.
- Increase the separation between the equipment and receiver.
- Connect the equipment into an outlet on a circuit different from that to which the receiver is connected.
- Consult the dealer or an experienced radio/TV technician for help.

The cable with the ferrite core provided with the digital camera must be used with this equipment in order to comply with Class B limits in Subpart B of Part 15 of the FCC rules.

Do not make any changes or modifications to the equipment unless otherwise specified in the manual. If such changes or modifications should be made, you could be required to stop operation of the equipment.

Canon U.S.A., Inc.

One Canon Plaza, Lake Success, NY 11042, U.S.A.

Tel No. (516) 328-5600

Canadian Radio Interference Regulations

This Class B digital apparatus complies with Canadian ICES-003.

Réglementation canadienne sur les interférences radio

Cet appareil numérique de la classe B est conforme à la norme NMB-003 du Canada.

Disclaimer



- While every effort has been made to ensure that the information contained in this guide is accurate and complete, no liability can be accepted for any errors or omissions.
- Canon reserves the right to change the specifications of the hardware and software described herein at anytime without prior notice.
- No part of this guide may be reproduced, transmitted, transcribed, stored in a retrieval system, or translated into any language in any form, by any means, without the prior written permission of Canon.
- Canon makes no warranties for damages resulting from corrupted or lost data due to a mistaken operation or malfunction of the camera, the software, SD memory cards (SD cards), personal computers, peripheral devices, or use of non-Canon SD cards.

Trademark Acknowledgments

- Microsoft, Windows Vista and the Windows Vista logo are trademarks of Microsoft Corporation in the United States and/or other countries.
- Macintosh, the Mac logo, QuickTime and QuickTime logo are trademarks of Apple Inc., registered in the U.S. and other countries.
- The SDHC logo is a trademark.

Functions Available in Each Shooting Mode

Set each function according to the shooting conditions and then shoot. Only functions with settings that change with the shooting mode are listed here.

Function		Shooting Mode							
		M	Av	Tv	P		AUTO		
Exposure Compensation (p. 114)		-	○	○	○	○	-	-	-
ISO Speed (p. 110)	Auto	-	○	○	○	○	○	○	○
	High ISO Auto	-	-	-	○	-	○	-	-
	ISO 80/100/200/400/800/1600	○	○	○	○	-	-	-	-
White Balance (p. 116)	Auto	○	○	○	○	○	○	○	○
	Day Light, Cloudy, Tungsten, Fluorescent, Fluorescent H, Custom	○	○	○	○	○	-	○	○
Drive Mode (pp. 91, 67)	Single Shot	○	○	○	○	○	○	○	○
	Continuous	○	○	○	○	-	-	-	-
	Continuous Shooting AF ¹⁾	○	○	○	○	-	-	-	-
	Self-Timer (2 sec./10 sec.)	○	○	○	○	○	○	○	○
	Self-Timer (Custom)	○	○	○	○	-	○	-	-
My Colors (p. 119)		○	○	○	○	○	-	○	○
Flash Exposure Compensation (p. 122)		-	○	○	○	○	-	-	-
Flash Output Control (p. 123)		○	○	○	-	-	-	-	-
Metering System (p. 115)	Evaluate	○	○	○	○	○	○	○	○
	Center-weighted Avg.	○	○	○	○	-	-	-	-
	Spot	○	○	○	○	-	-	-	-
Number of Recording Pixels/Compression Selection (still images) (pp. 69, 70)		○	○	○	○	○ ²⁾	○	-	-
Number of Recording Pixels/Frame Rate Selection (movies) (p. 82)	640 × 480, 30 fps/30 fps LP	-	-	-	-	-	-	○	-
	320 × 240, 30 fps	-	-	-	-	-	-	○	-
	160 × 120, 15 fps	-	-	-	-	-	-	-	○
Av/Tv Setting (pp. 88, 86)		○	○ ³⁾	○ ⁴⁾	-	-	-	-	-
Program Shift (p. 108)		-	○	○	○	-	-	-	-
AE/FE Lock (still images) (pp. 107, 109)		-	○	○	○	-	-	-	-
Exposure Shift (movies) (p. 81)		-	-	-	-	-	-	○	○
Shooting Zone (Macro) (p. 66)		○	○	○	○	○	○	○	○
Manual Focus (p. 105)		○	○	○	○	-	-	○	○
Flash ⁵⁾ (p. 65)	Auto	-	-	-	○	-	○	-	-
	On	○	○	○	○	○	-	-	-
	Off	○	○	○	○	○	○	-	-
LCD Monitor Setting (p. 51)	LCD Monitor (no information)	○	○	○	○	-	○	○	○
	LCD Monitor (information view)	○	○	○	○	○	○	○	○
Stitch Direction Selection (Right, Left) (p. 83)		-	-	-	-	○	-	-	-

Function		Shooting Mode							
		M	Av	Tv	P		AUTO		
AF Frame (p. 98)	Face Detect	○	○	○	○	—	○	—	—
	Center	○	○	○	○	○	○	○	○
AF Frame Size (p. 100)		○	○	○	○	—	—	—	—
Digital Zoom (p. 61)	Standard	○	○	○	○	—	○	○	—
	Digital Tele-converter	○	○	○	○	—	○	—	—
Flash	Slow Synchro (p. 94)	○ ⁶⁾	○	○ ⁶⁾	○	○	—	—	—
	Flash Adjust (Off) (p. 121)	○ ⁷⁾	○	○	—	—	—	—	—
	Red-Eye (p. 93)	○	○	○	○	○	○	—	—
Safety FE (p. 124)		—	○	○	○	—	—	—	—
Safety Shift (p. 89)		—	○	○	—	—	—	—	—
Auto ISO Shift (p. 111)	button/On	—	○	—	○	—	○	—	—
	Off	○	○	○	○	○	○	○	○
MF-Point Zoom (p. 105)		○	○	○	○	—	—	—	—
Safety MF (p. 106)		○	○	○	○	—	—	○	○
Self-Timer (Custom Timer) (p. 68)		○	○	○	○	—	○	—	—
AF Mode (p. 97)	Continuous	○	○	○	○	○	○	—	—
	Single	○	○	○	○	○	○	○	○
AF-assist Beam		○	○	○	○	○	○	○	○
Review (Rec. review) (p. 16)		○	○	○	○	○	○	—	—
Review Info (p. 95)	Off	○	○	○	○	○	○	—	—
	Detailed / Focus Check	○	○	○	○	—	○	—	—
Disp. Overlay (p. 127)	Grid Lines	○	○	○	○	—	○	○	○
	3:2 Guide/Both	○	○	○	○	—	○	—	—
IS Mode (p. 73)	Continuous	○	○	○	○	○	○	○	○
	Shoot Only / Panning	○	○	○	○	○	○	—	—
Date Stamp (p. 72)		○	○	○	○	—	○	—	—
Set button (p. 125)		○	○	○	○	○	○	○	○

○ : Setting available or optimum value is automatically set by the camera. As a rule, with the "Stitch Assist", only the first image is available.

— : Not available

■ : The settings are retained even when the camera power is turned off.

- (1) Set to Continuous Shooting LV when Manual Focus or is selected.
- (2) Postcard Date Imprint and Widescreen are not available.
- (3) Only **Av** (Aperture Value) can be set.
- (4) Only **Tv** (Shutter Speed) can be set.
- (5) Cannot fire when flash is not raised.
- (6) Always set to on.
- (7) Cannot be set to on.
- (8) Only available when Flash-on is selected.

